

081



ALP智能型低压线路保护器

安装使用说明书 V2.1

ALP intelligent low line protector
Installation and operation instruction V2.1

安科瑞电气股份有限公司

ACREL Electrical Co., Ltd.

申 明

Declaration

版权所有，未经本公司之书面许可，此手册中任何段落，章节内容均不得被摘抄、拷贝或以任何其它形式复制、传播，否则一切后果由违者自负。

All rights reserved. Any section or chapter content in the manual shall not be extracted, copied or duplicated or spread in any form without the written permission of our company. Otherwise, all the consequences arising from it shall be borne to the violator.

本公司保留一切法律权利。

Our company will reserve all the legal rights.

本公司保留对本手册所描述之产品规格进行修改的权利，恕不另行通知。订货前，请垂询当地代理商以获悉本产品的最新规格。

Our company will reserve the right to modify the product specification described in the manual without prior notice. Before placing an order, please inquire the local agents to get the latest specification of the product.

目录 Contents

1 概述 OVERVIEW	4
2 产品特点 PRODUCT CHARACTERISTIC	4
3 型号说明 MODEL DESCRIPTION.....	5
4 主要技术指标 MAIN TECHNICAL INDEXEX.....	5
5 功能配置 FUNCTION CONFIGURATION	7
6 安装与接线 INSTALLATION AND WIRING	10
6.1 安装说明 INSTALLATION INSTRUCTIONS.....	10
6.2 控制器模块外形及安装尺寸 OUTLINE AND INSTALLING DIMENSION OF CONTROLLER MODULE	10
6.3 ALP220、ALP320 系列 1A/5A 专用电流互感器外形尺寸 OUTLINE DIMENSION OF ALP220, ALP320 SERIES 1A/5A SPECIAL CURRENT TRANSFORMER	12
6.4 100A 及以下电流互感器模块外形尺寸 OUTLINE DIMENSION OF 100A AND BELOW CURRENT TRANSFORMER MODULE.....	13
6.5 160A 电流互感器外形尺寸 OUTLINE DIMENSION OF 160A CURRENT TRANSFORMER	13
6.6 400A 电流互感器外形尺寸 OUTLINE DIMENSION OF 400A CURRENT TRANSFORMER	14
6.7 漏电流互感器外形尺寸 OUTLINE DIMENSION OF LEAKAGE CURRENT TRANSFORMER	14
6.8 ALP320 显示模块外形尺寸 OUTLINE DIMENSION OF ALP320 DISPLAY MODULE	15
6.8 端子排列 TERMINAL ARRANGEMENT	16
6.9 端子编号 TERMINAL NUMBER.....	17
6.10 产品组成 PRODUCT COMPOSITION	21
7 操作指南 OPERATION INSTRUCTIONS	28
7.1 显示操作说明 DISPLAY OPERATION INSTRUCTIONS.....	28
7.2 ALP200 及 ALP220 菜单概述 OVERVIEW OF ALP200 AND ALP220 MENU	33
7.3 ALP320 菜单概述 OVERVIEW OF ALP320MENU	41
7.4 ALP 各菜单详细描述 DETAILED DESCRIPTION OF ALP MENUS	49
7.5 ALP 保护功能介绍 FUNCTIONAL INTRODUCTION OF ALP PROTECTION.....	60
8 通讯 COMMUNICATION	65
8.1 MODBUS RTU 通信协议概述 OVERVIEW OF MODBUS COMMUNICATION PROTOCOL.....	65
8.2 ALP 系列通讯地址表 ALP SERIES COMMUNICATION ADDRESS TABLE	66
9.典型应用原理图 TYPICAL APPLICATION SCHEMATIC DIAGRAM	95
9.1 ALP200 装置接线图 ALP200 DEVICE WIRING DIAGRAM.....	95
9.2 ALP220 装置接线图 ALP220 DEVICE WIRING DIAGRAM	错误!未定义书签。
9.3 ALP320 装置接线图 ALP320 DEVICE WIRING DIAGRAM	错误!未定义书签。

1 概述 Overview

ALP200、ALP220、ALP320 系列智能型低压线路保护器（以下简称 ALP），适用于额定电压至 AC 660V、额定电流至 AC 400A、额定频率为 50/60Hz 的低压系统。产品体积小，结构紧凑，安装方便，是低压馈线终端的保护、监测和控制的智能化综合装置。

ALP200, ALP220 and ALP320 series intelligent low line protectors (hereinafter referred to as ALP) apply to low-voltage system with rated voltage to AC 600V, rated current to AC 400A and rated frequency of 50/60Hz. The product is small in volume, compact in structure and convenient in installation, which is intelligent integrated unit for protecting, monitoring and controlling low voltage feeder terminal.

ALP 系列产品集保护、测量、控制、总线通讯为一体，同时提供了远程自动控制、现场直接控制、面板指示、信号报警、操作记录、跳闸报警记录及开关量记录等功能。适用于煤矿、石化、冶炼、电力、船舶、以及民用建筑等领域。

ALP series products have integrated protection, measurement, control and bus communication into one and provided remote auto control, site direct control, panel indication, signal alarm, operation record, trip alarm record and switch quantity record and other functions, applying to coal mine, petrification, smelting, electricity, ship and civil architecture and other fields.

2 产品特点 Product features

- 辅助电源支持 AC 85V~265V/DC 110V~350V 或 AC 380V±10%（需另配 380V 电源模块）。
- The auxiliary power supply (APS) supports AC 85V~265V/DC 110V~350V or AC 380V±10% (380V power module shall be equipped additionally).
- 测量功能包括保护回路的电流、电压测量和其他参数如功率、剩余电流（漏电流）的测量。
- The measurement function includes the current and voltage measurement of protection circuit and the measurement of other parameters such as power, residual current (leakage current)
- 具有反时限过流、低定时限过流、高定时限过流、低定时限零序、高定时限零序、反时限零序、断相保护、电流不平衡、需量保护、联动保护、欠压保护、过压保护、漏电保护等功能。
- It has inverse time over current, low definite-time over current, high definite-time over current, low definite-time zero sequence, high definite-time zero sequence, inverse time zero sequence, open-phase protection, current unbalance, demand protection, linkage protection, under-voltage protection, over-voltage protection, leakage protection and other functions.
- 过流保护和零序过流保护具有多个反时限特性可选。
- Overcurrent protection and zero sequence over current protection have several inverse time characteristics to choose from.
- 最多 9 路 DI 无源干接点输入，信号电源采用内置 DC24V 电源。
- At most 9-circuit DI passive dry contact input and signal power adopts built-in DC24V power supply.
- 最多 5 路 DO 输出，用于保护跳闸、遥控和报警。
- At most 5-circuit DO output is used to protect the trip, remote control and alarm.
- 具有标准的 RS-485 通讯接口，采用 ModbusRTU，保证了上位机通讯的快速可靠。
- It has standard RS-485 communication interface and ModbusRTU is adopted, which has guaranteed the rapid and reliable upper computer communication.
- 具有 DC4-20mA 模拟量输出接口，可设定多项模拟量参数。
- It has DC4-20mA analog output interface and can set several analog parameters.
- 具有系统时钟和 8 次故障记录功能，系统时钟记录当前时间（日、时、分、秒），故障记录功能记录故障原因。
- It has system clock and can record 8 failures. The system clock will record the current time (day, hour, minute, second) and the failure record function will record the failure cause.

- 采用全中文液晶显示界面。
- All-Chinese LCD interface is adopted.

3 型号说明 Model description

表 1 ALP 系列型号说明
Table 1 ALP series model description

产品型号 Product model	电流规格 (A) Current specification (A)		附加功能 Additional functions	备注 Remarks
ALP200-□/□ □	1	1-6300 (变比可设) (No-load voltage ratio can be set)		96B 外形 嵌入式安装 (开孔尺寸 91×44) 96B outline: Embedded installation (hole size: 91×44)
	5	1-6300 (变比可设) (No-load voltage ratio can be set)		
	25	6-25		
	100	20-100		
	160	80-160		
	400	140-400		
ALP220-□/□ □	1	1-6300 (变比可设) (No-load voltage ratio can be set)	L: 剩余电流 (漏电) L: Residual current (electric leakage) M: 模拟量输出 M: Analog output	96 外形 嵌入式安装 (开孔尺寸 88×88) 96 outline: Embedded installation (hole size: 88×88)
	5	1-6300 (变比可设) (No-load voltage ratio can be set)		
	25	6-25		
	100	20-100		
	160	80-160		
	400	140-400		
ALP320-□/□ □	1	1-6300 (变比可设) (No-load voltage ratio can be set))		控制器模块导轨式安装, 90L 分体液晶显示模块为嵌入式安装 (尺寸 90×70, 开孔 86×66) Controller module: guide rail type installation; 90L split LCD display module: embedded installation (size: 90x 70, hole: 86x66)
	5	1-6300 (变比可设) (No-load voltage ratio can be set))		
	25	6-25		
	100	20-100		
	160	80-160		
	400	140-400		

订货范例: Example of ordering goods:

如需 ALP200 低压线路保护器提供如下功能:

If ALP200 low line protector is needed to provide following functions:

电流规格 1A、带 4-20mA 变送输出、带漏电流测量

Current specification 1A, with 4-20mA transmitting output, with leakage current measurement

对应型号: “ALP200-1A/ML”

Corresponding model: “ALP200-1A/ML”

如需 ALP220 低压线路保护器提供如下功能:

If ALP220 low line protector is needed to provide following functions:

电流规格 100A、带 4-20mA 变送输出

Current specification 100A, with 4-20mA transmitting output

对应型号: “ALP220-100A/M”

Corresponding model: “ALP220-100A/M”

如需 ALP320 低压线路保护器提供如下功能:

If ALP320 low line protector is needed to provide following functions:

电流规格 400A、带 4-20mA 变送输出、带漏电流测量

Current specification 400A, with 4-20mA transmitting output, with leakage current measurement

对应型号: “ALP320-400A/ML”

Corresponding model: “ALP320-400A/ML”

4 主要技术指标 Main technical indexes

表 2 主要技术指标
Table 1 Main technical indexes

技术参数 Technical parameters		技术指标 Technical indexes	
精度等级 Accuracy class		电流 2.5 级 电压 1.0 级 Current: 2.5 grade; voltage: 1.0 grade	
辅助电源 Auxiliary power supply		AC 85V~265V/DC 110V~350V 或 AC 380V±10%, 功耗 15VA AC 85V~265V/DC 110V~350V or AC 380V±10%, power consumption: 15VA	
保护 线路 Protect ion circuit	额定工作电压 Rated operational voltage	AC220V / 380V / 660V, 50Hz / 60Hz (默认工作电压 380V, 其余电压型号需特殊标注) AC220V / 380V / 660V, 50Hz / 60Hz (the default operational voltage is 380V; the other voltage models shall be labeled specifically)	
	额定工作电流 Rated operational current	1 (1A-6300A)	采用小型专用电流互感器检测模块 (1、5 规格需将一次侧接入变比为 ××/1、××/5 的互感器, 后将二次侧 信号接入我司提供的互感器) Adopt small-sized special current transformer detection module (for 1, 5 specification, connect primary side with the transformer with no-load voltage ratio as ××/1, ××/5 and then connect the secondary side with transformer provided by our company)
		5 (1A-6300A)	
		25 (6A-25A)	
100 (20A-100A)			
	160 (80A-160A)	采用外置电流互感器	

	400(140A-400A)	External current transformer is adopted
继电器输出触点容量 Relay output contact capacity	阻性负载 Resistance load	ALP200、ALP220: 1路(95.96.97): AC 250V 3A/DC 30V 3A 3路: AC 250V 5A/DC 30V 5A ALP200、ALP220: 1-circuit (95.96.97): AC 250V 3A/DC 30V 3A 3-circuit: AC 250V 5A/DC 30V 5A
		ALP320: 5路继电器输出 AC 250V 6A 5-circuit relay output: AC 250V 6A
开关量输入 Switch input	ALP200、ALP220: 5路无源干接点 ALP200, ALP220: 5-circuit passive dry contact	
	ALP320: 9路无源干接点 ALP320: Circuit-9 passive dry contact	
通讯 Communication	MODBUS_RTU	
环境 Environment	工作温度 Operating temperature	-10°C~55°C
	贮存温度 Storage temperature	-25°C~70°C
	相对湿度 Relative humidity	≤95% 不结露, 无腐蚀性气体 ≤95% non-condensate, no corrosive gas
	海拔 Elevation	≤2000m
污染等级 Pollution degree	2级 2-grade	
防护等级 IP grade	主体 IP20, 分体显示模块 IP54 (安装在柜体面板时) Main body: IP20; split display module: IP54 (when installing cabinet panel)	
安装类别 Installation category	III级 III-grade	

5 功能配置 Functional configuration

产品功能配置如表 3 所示。

The product function configuration is shown in Table 3.

表 3 功能配置

Table 3 Functional configuration

功能 Function	配置 Configuration	标配功能 Standard configurati on function	选配功能 Optional functions
保护功能 Protection function	反时限过流保护 Inverse time over current protection	√	
	低定时限过流保护 Low definite-time over current protection	√	
	高定时限过流保护 High definite-time over current protection	√	
	低定时限零序保护 Low definite-time zero sequence protection	√	
	高定时限零序保护 High definite-time zero sequence protection	√	
	反时限零序保护 Inverse time zero sequence protection	√	
	断相保护 Open-phase protection	√	
	不平衡保护 Unbalance protection	√	
	电流需量保护 Current demand protection	√	
	联动 1 保护 Linkage 1 protection	√	
	联动 2 保护 Linkage 2 protection	√	
	联动 3 保护 Linkage 3 protection	√	
	欠压保护 (ALP220、ALP320 支持) Undervoltage protection (ALP220, ALP320 support)	√	
	过压保护 (ALP220、ALP320 支持) Overvoltage protection (ALP220, ALP320 support)	√	
	漏电保护 Leakage protection		√ (漏电功能) (leakage function)

通讯功能 Communication function	RS485 接口通讯协议: ModbusRTU RS485 interface communication protocol: ModbusRTU	√	
开关量输入 Switch input	开关量输入 DI (ALP200、ALP220 支持 5 路 DI, ALP320 支持 9 路 DI) Switch input DI (ALP200, ALP220 support 5-circuit DI, ALP320 support 9-circuit DI)	√	
继电器输出 Relay output	开关量输出 DO (ALP200、ALP220 支持 4 路 DO, ALP320 支持 5 路 DO) Switch output DO (ALP200, ALP220 support 4-circuit DI, ALP320 support 5-circuit DI)	√	
模拟量输出 Analog output	一路 DC4-20mA 1-circuit DC4-20mA		√ (模拟量功能) (Analog function)
记录 Record	8 条故障记录, 记录线路发生故障的原因、时间, 发生故障时线路的各参数 8 条分闸、合闸记录 8 条 DI 动作记录 8 failure records; the failure cause, time, parameters of circuit during failure are recorded	√	
测量显示 Measurement display	三相电流、频率 Three-phase current, frequency	√	
	三相线电压 (ALP220、ALP320 支持, 三相四线系统时显示的是相电压)、功率、功率因数、电能 Triple-phase line voltage (ALP220, ALP320 support. Display phase voltage in three-phase four-wire system), power, power factor, electric energy)	√	
定值设定 Definite value setting	各种保护定值查询 Query of various protection definite values	√	
	各种保护定值设定 Setting of various protection definite values	√	

6 安装与接线 Installation and wiring

6.1 安装说明 Installation instructions

ALP200、ALP220 控制模块、ALP320 显示模块采用嵌入式安装，按照开孔尺寸在柜体表面开好安装孔，通过锁紧件固定在柜体表面上；ALP320 主体控制模块采用导轨安装，直接卡接在导轨上；互感器采用螺丝固定方式安装。

ALP200, ALP220 control module and ALP320 display module shall adopt embedded installation: open the mounting hole on the cabinet surface according to hole size and fix on cabinet surface through retaining member; ALP320 main body control module shall adopt guide rail installation to directly connect on guide rail; the transformer shall adopt the screw fixation installation way.

注：ALP200 系列 1A 规格的低压线路保护器专用互感器需绕线 5 圈，ALP220、ALP320 系列 1A 规格的低压线路保护器专用互感器需绕线 8 圈，ALP 系列 5A 规格的低压线路保护器专用互感器需绕线 2 圈。

Note: The special transformer for ALP200 series low line protector of 1A specification shall wrap the line for 5 turns; the special transformer for ALP220, ALP320 series low line protector of 1A specification shall wrap the line for 8 turns; the special transformer for ALP series low line protector of 5A specification shall wrap the line for 2 turns.

6.2 控制器模块外形及安装尺寸 Outline and installing dimensions of controller module

ALP200 控制模块外形尺寸如图 1 所示。（单位：mm）

The outline dimension of ALP200 control module is shown in Figure 1. (Unit: mm)

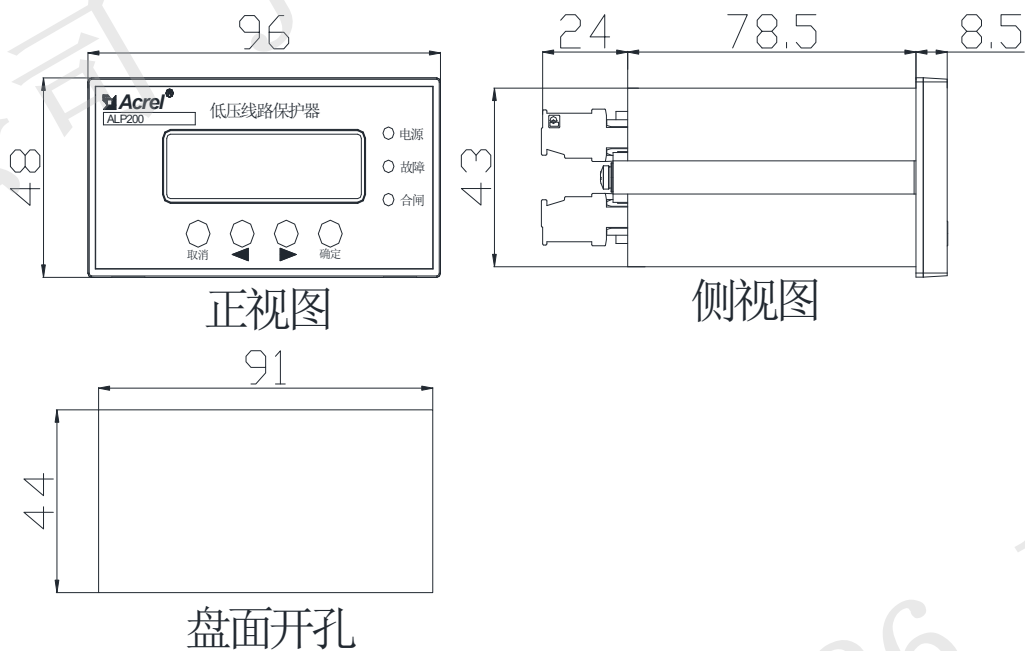

正视图	Front view
侧视图	Side view
盘面开孔	Disk surface hole

图 1 ALP200 控制模块外形及安装尺寸

Figure 1 Outline and installing dimension of ALP200 control module

ALP220 控制模块外形尺寸如图 2 所示。（单位：mm）

The outline dimension of ALP220 control module is shown in Figure 2. (Unit: mm)



图 2 ALP220 控制模块外形及安装尺寸

Figure 2 Outline and installing dimension of ALP220 control module

正视图	Front view
侧视图	Side view
盘面开孔	Disk surface tapping

ALP320 主体控制模块采用标准 DIN35 导轨安装,其外形尺寸如图 3 所示。

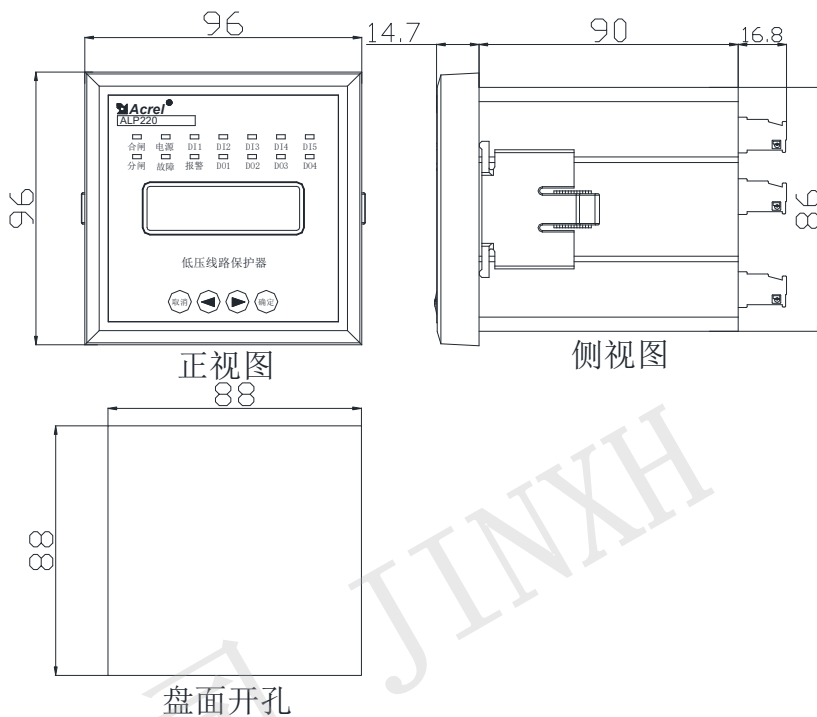
ALP320 main control module adopts standard DIN35 guide rail installation and the outline dimension is shown in Figure 3.

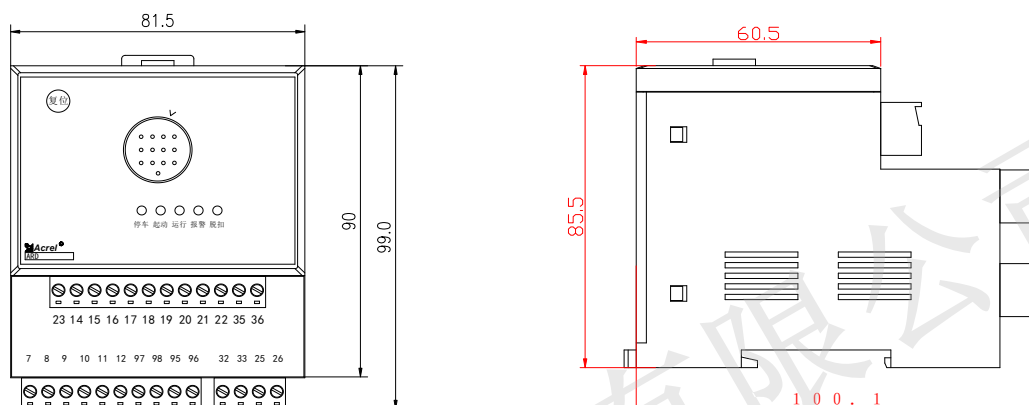



图 3 ALP320 主体控制模块外形及安装尺寸
Figure 3 Outline and installing dimension of ALP320 main control module

6.3 ALP220、ALP320 系列 1A/5A 专用电流互感器外形尺寸 Outline dimension of ALP220, ALP320 series 1A/5A special current transformer

ALP220、ALP320 系列 1A/5A 专用电流互感器外形尺寸如图 4 所示。

The outline dimension of ALP220, ALP320 series 1A/5A special current transformer is shown in Figure 4.

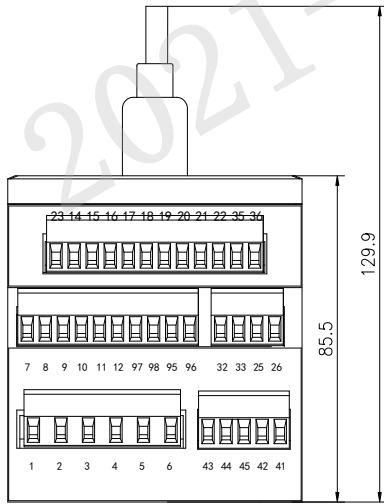
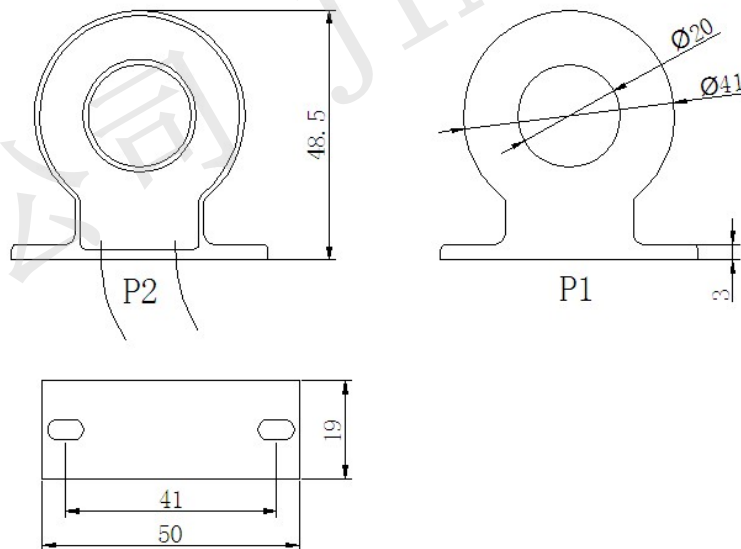

注：一次电流从P1面进，P2面（灌胶面）出，二次引出线红色为S1，黄色为S2，引出线长2m。

图 4 ALP220、ALP320 系列 1A/5A 专用电流互感器外形尺寸图
Figure 4 Outline drawing of ALP220, ALP320 series 1A/5A special current transformer

注：一次电流从 P1 面进，若 P2 面（灌浇面）出，二次引线黄色为 S2，红色为 S1，引线长 2m)	Note: Primary current goes in from P1 surface and out from P2 surface (pouring surface); secondary lead yellow is S2, red is S1 and the lead is 2m long)
黄色 红色	Yellow, red

6.4 100A 及以下电流互感器模块外形尺寸 Outline dimension of 100A and below current transformer module

100A 及以下的专用电流互感器外形尺寸如图 5 所示。

The outline dimension of 100A and below special current transformer is shown in Figure 5.



图 5 100A 及以下的电流互感器外形尺寸
Figure 5 Outline dimension of 100A and below current transformer

6.5 160A 电流互感器外形尺寸 Outline dimension of 160A current transformer

当线路额定电流为 100A~160A 时，使用的电流互感器外形尺寸如图 6 所示。

When the rated current of line is 100A-160A, the outline drawing of current transformer for use is shown in Figure 6.

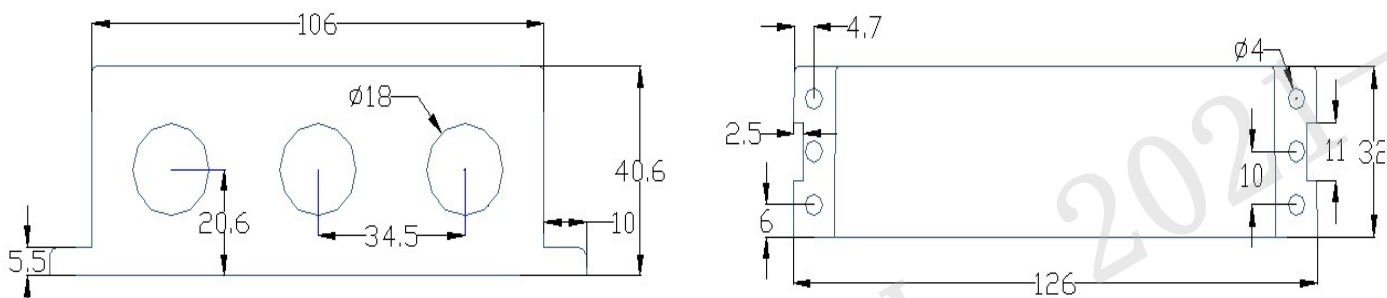

图 6 160A 电流互感器外形尺寸
Figure 6 Outline drawing of 160A current transformer

6.6 400A 电流互感器外形尺寸 Outline dimension of 400A current transformer

当线路额定电流为 160A~400A 时，使用的电流互感器外形尺寸如图 7 所示。

When the rated current of line is 160A-400A, the outline drawing of current transformer for use is shown in Figure 7.

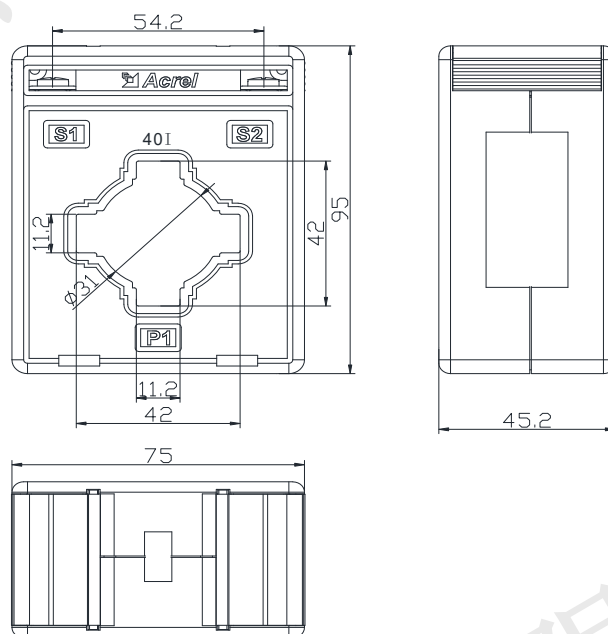

图 7 400A 电流互感器外形尺寸

Figure 7 Outline drawing of 400A current transformer

6.7 漏电流互感器外形尺寸 Outline dimension of leakage current transformer

1A、5A 漏电流互感器外形尺寸见图（一）、图（二）、图（三），25A、100A 漏电流互感器 AKH-0.66 L-45 外形尺寸见图（三），160A、400A 漏电流互感器 AKH-0.66 L-100 外形尺寸见图（三）。

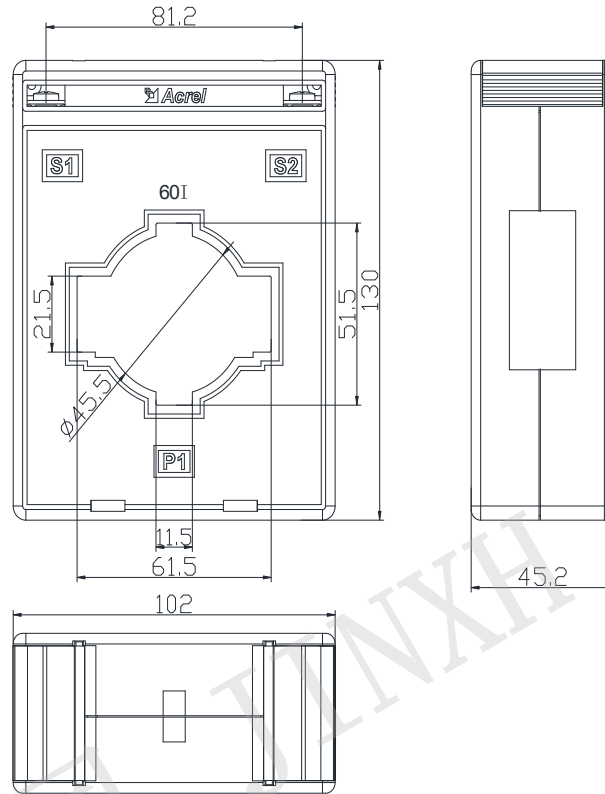
See Figure (I), Figure (II) and Figure (III) for the outline dimension of 1A, 5A leakage current transformer; see Figure (III) for 25A, 100A leakage current transformer AKH-0.66L-45 and see Figure (III) for outline dimension of 160A, 400A leakage current transformer AKH-0.66L-100.

规格 Specification	外形尺寸 Outline dimension (mm)			穿孔尺寸 Perforation size(mm)		安装尺寸 Mounting dimension (mm)	
	W	H	D	a	e	M	N
AKH-0.66 L-80×50II	120	141	45	82	52	60	70.5
AKH-0.66 L-100×50II	145	155	50	103	55	80	70.5
AKH-0.66 L-130×50II	176	160	50	135	55	85	70.5
AKH-0.66 L-150×130II	199	245	50	150	133	71	70.5
AKH-0.66 L-180II	228	115	48	181	35	102	70.5
AKH-0.66 L-200×50II	247	175	55	207	61	188	83
AKH-0.66 L-260×100II	308	225	63	265	104	181	83



图 (一) Figure (I)



图 (二) Figure (II)

尺寸 Dimension 规格 Specification	外形尺寸(mm) Outline dimension (mm)			穿孔尺寸(mm) Perforation size(mm)	
	W	H	D	a	e
AKH-0.66 L-170×30	212	82	40	172	34
AKH-0.66 L-210×160	260	214	50	210	160
AKH-0.66 L-260×160	310	213	50	260	160
AKH-0.66 L-300×50	352	103	50	300	50
AKH-0.66 L-350×50	403	104	50	350	50
AKH-0.66 L-400×50	453	103	50	400	50
AKH-0.66 L-400×160	450	213	50	400	160
AKH-0.66 L-500×50	548	102	50	497	50
AKH-0.66 L-650×50	705	103	50	655	50
AKH-0.66 L-800×50	852	104	50	800	50
AKH-0.66 L-780×160	830	212	50	780	160

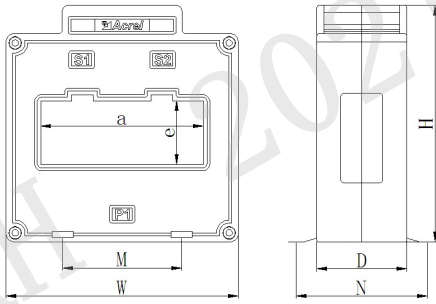

图 (三) Figure (III)

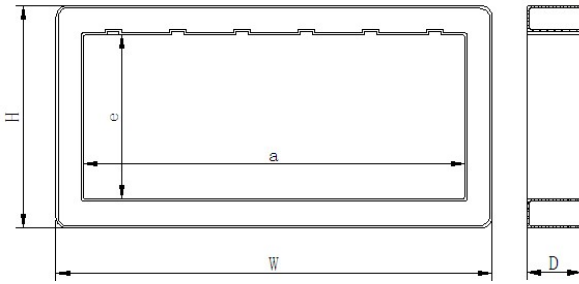
尺寸 Dimension 规格 Specification	外形尺寸(mm) Outline dimension (mm)			穿孔尺寸(mm) Perforation size(mm)	安装尺寸(mm) Mounting dimension (mm)			公差 Tolerance (mm)	重量 Weight (g)
	W	H	D		Φ	M	N		
AKH-0.66 L-45	75	75	22	46	65	65	4	±1	200±10
AKH-0.66 L-80	120	120	23	81	105	105	4		380±20
AKH-0.66 L-100	140	140	23	100	124	124	4		460±30
AKH-0.66 L-150	196	205	24	150	175	180	6		850±50
AKH-0.66 L-200	240	247	28	200	214	212	6		1200±50

6.8 ALP320 显示模块外形尺寸 Outline dimension of ALP320 display module

ALP320 显示模块外形尺寸如图 8 所示。

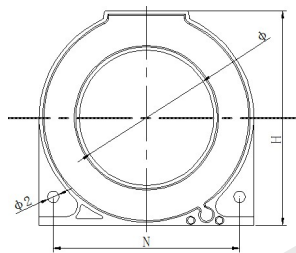
The outline dimension of ALP320 display module is shown in Figure 8.



图 8 90L 显示模块外形及安装尺寸

Figure 8 Outline and installing dimension of display module

低压线路保护器	Low line protector
电源、合闸、分闸	Power supply, opening, closing
远程、报警、脱扣	Remote, alarm, tripping
合闸、分闸、取消、确定	Closing, opening, cancel, confirm
开孔尺寸	Hole size

6.8 端子排列 Terminal arrangement

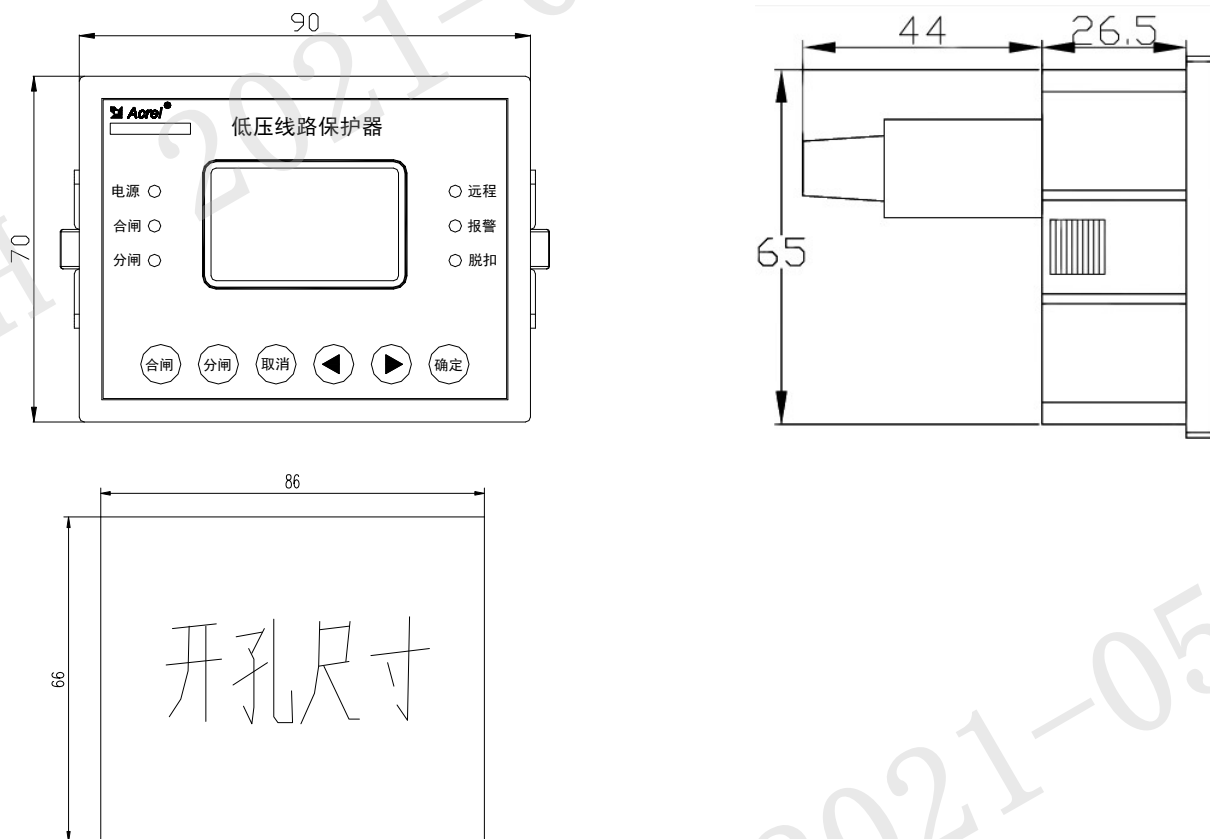
ALP200 接线端子如图 9 所示：

ALP200 wiring terminal is shown in Figure 9:

1	2	97	95	96	7	8	9	10	11	12	36	35
L	N	D01			D02		D03		D04		I0-	I0+

43	44	45	42	41	40	25	26		14	15	16	17	18	23
Ia	Ib	Ic	COM3	IL*	IL	A1	B1		DI1	DI2	DI3	DI4	DI5	COM1

图 9 ALP200 接线端子

Figure 9 ALP200 wiring terminal

ALP220 接线端子如图 10 所示

ALP220 wiring terminal is shown in Figure 10.

4	5	6	3	43	44	45	42	41	40
Ua	Ub	Uc	Un	Ia	Ib	Ic	COM3	IL*	IL

14	15	16	17	18	23	35	36	25	26
DI1	DI2	DI3	DI4	DI5	COM1	IO+	IO-	A1	B1

L	N		D01	D02	D03	D04
1	2		95	96	97	7 8 9 10 11 12

图 10 ALP220 接线端子

Figure 10 ALP220 wiring terminal

ALP320 接线端子如图 11 所示。

ALP320 wiring terminal is shown in Figure 11.

23	14	15	16	17	18	19	20	21	22	35	36
COM1	DI1	DI2	DI3	DI4	DI5	DI6	DI7	DI8	DI9	IO+	IO-

7	8	9	10	11	12	97	98	95	96	33	25	26
D01	D02	D03	D04	D05							A1	B1

1	2	3	4	5	6	43	44	45	42	41
L	N	Un	Ua	Ub	Uc	Ia	Ib	Ic	COM3	IL*

图 11 ALP320 接线端子

Figure 11 ALP320 wiring terminal

6.9 端子编号 Terminal No.

ALP200 接线端子编号如表 4 所示。

ALP200 wiring terminal No. is shown in Table 4.

表 4 ALP200 接线端子标识及功能定义

Table 4 Identification and function definition of ALP200 wiring terminal

端子号 Terminal No.	功能定义 Function definition	备注 Remarks
1	电源输入 L (直流时为+) Mains input L (It is + when it is DC)	辅助电源 Auxiliary power supply
2	电源输入 N (直流时为-) Mains input N (It is - when it is DC)	
95, 96, 97	DO1 (默认脱扣继电器) 其中: 95、96 常闭, 95、97 常开 DO1 (Default: tripping reply) In which: 95, 96 normally closed; 95, 97 normally open	继电器输出 (DO) Relay output (DO)
7, 8	DO2 (默认分闸继电器) DO2 (Default: opening relay)	
9, 10	DO3 (默认合闸继电器) DO3 (default: closing relay)	
11, 12	DO4 (默认普通 DO) DO4 (default: common DO)	

14	DI1 (断路器状态) DI1 (breaker status)	开关量输入 (DI) Switch input (DI)
15	DI2 (本地分闸) DI2 (local opening)	
16	DI3 (本地合闸) DI3 (local closing)	
17	DI4 (复位) DI4 (reset)	
18	DI5 (普通 DI) DI5 (common DI)	
23	COM1 (DI 输入公共端 DC24V (内置电源)) COM1 (DI input common terminal DC24V (built-in power supply))	
25	A1	RS485 通讯接口 RS485 communication interface
26	B1	
35	模拟量输出 IO+ Analog output IO+	模拟量输出 Analog output
36	模拟量输出 IO- Analog output IO-	
40	Icom 漏电流输入 Icom leakage current input	漏电流输入 Leakage current input
41	IL*漏电流输入 IL* leakage current input	
42	COM3(电流输入公共端) COM3 (current input common terminal)	三相电流输入 Three-phase current input
43	Ia A 相电流输入 Ia A-phase current input	
44	Ib B 相电流输入 Ib B-phase current input	
45	Ic C 相电流输入 Ic C-phase current input	

ALP220 端子标志见表 5 所示。

ALP220 terminal logo is shown in Table 5.

表 5 ALP220 端子标识及功能定义

Table 5 Identification and function definition of ALP220 terminal

端子号 Terminal No.	功能定义 Function definition	备注 Remarks
1	电源输入 L (直流时为+) Mains input L (It is + when it is DC)	辅助电源 Auxiliary power supply
2	电源输入 N (直流时为-) Mains input N (It is - when it is DC)	

95, 96, 97	DO1 (默认脱扣继电器) 其中: 95、96 常闭, 95、97 常开 DO1 (Default: tripping reply) In which: 95, 96 normally closed; 95, 97 normally open	继电器输出 (DO) Relay output (DO)
7, 8	DO2 (默认分闸继电器) DO2 (Default: opening relay)	
9, 10	DO3 (默认合闸继电器) DO3 (default: closing relay)	
11, 12	DO4 (默认普通 DO) DO4 (default: common DO)	
14	DI1 (断路器状态) DI1 (breaker status)	开关量输入 (DI) Switch input (DI)
15	DI2 (本地分闸) DI2 (local opening)	
16	DI3 (本地合闸) DI3 (local closing)	
17	DI4 (复位) DI4 (reset)	
18	DI5 (普通 DI) DI2 (common DI)	
23	COM1 (DI 输入公共端 DC24V (内置电源)) COM1 (DI input common terminal) DC24V (built-in power supply)	
25	A1	RS485 通讯接口 RS485 communication interface
26	B1	
35	模拟量输出 IO+ Analog output IO+	模拟量输出 Analog output
36	模拟量输出 IO- Analog output IO-	
40	IL 漏电流输入 IL leakage current input	漏电流输入 Leakage current input
41	IL*漏电流输入 IL* leakage current input	
42	COM3(电流输入公共端) COM3 (current input common terminal)	三相电流输入 Three-phase current input
43	Ia A 相电流输入 Ia A-phase current input	
44	Ib B 相电流输入 Ib B-phase current input	
45	Ic C 相电流输入 Ic C-phase current input	
3	Un 输入 Un input	三相电压输入 Three-phase

4	Ua A 相电压输入 Ua A-phase voltage input	voltage input
5	Ub B 相电压输入 Ub B-phase voltage input	
6	Uc C 相电压输入 Uc C-phase voltage input	

ALP320 接线端子编号如表 6 所示。

ALP320 wiring terminal No. is shown in Table 6.

表 6 ALP320 端子标识及功能定义

Table 6 Identification and function definition of ALP320 terminal

端子号 Terminal No.	功能定义 Function definition	备注 Remarks
1	电源输入 L (直流时为+) Mains input L (It is + when it is DC)	辅助电源 Auxiliary power supply
2	电源输入 N (直流时为-) Mains input N (It is - when it is DC)	
3	Un 输入 Un input	三相电压输入 Three-phase voltage input
4	Ua A 相电压输入 Ua A-phase voltage input	
5	Ub B 相电压输入 Ub B-phase voltage input	
6	Uc C 相电压输入 Uc C-phase voltage input	
7, 8	DO1 (默认脱扣继电器) DO1 (Default: tripping relay)	继电器输出 (DO) Relay output (DO)
9, 10	DO2 (默认分闸继电器) DO2 (Default: opening relay)	
11, 12	DO3 (默认合闸继电器) DO3 (Default: closing relay)	
97, 98	DO4 (默认普通 DO)	
95, 96	DO5 (默认普通 DO) DO5 (default: common DO)	
14	DI1 (断路器状态) DI1 (breaker status)	开关量输入 (DI) Switch input (DI)
15	DI2 (本地分闸) DI3 (local opening)	
16	DI3 (本地合闸) DI3 (local closing)	
17	DI4 (复位) DI4 (reset)	
18	DI5 (普通 DI) DI5 (common DI)	
19	DI6 (普通 DI) DI6 (common DI)	

20	DI7 (普通 DI) DI7 (common DI)	
21	DI8 (普通 DI) DI8 (common DI)	
22	DI9 (普通 DI) DI9 (common DI)	
23	COM1 (DI 输入公共端 DC24V (内置电 源)) COM1 (DI input common terminal DC24V (built-in power supply))	
25	A1	
26	B1	RS485 通讯接 口 RS485 communication interface
35	模拟量输出 IO+ Analog output IO+	模拟量输出 Analog output
36	模拟量输出 IO- Analog output IO-	
41	IL*漏电流输入 IL*leakage current input	三相电流输入 Three-phase current input
42	COM3(电流输入公共端) COM3 (current input common terminal)	
43	Ia A 相电流输入 Ia A-phase current input	
44	Ib B 相电流输入 Ib B-phase current input	
45	Ic C 相电流输入 Ic C-phase current input	

6.10 产品组成 Product composition

ALP 低压线路保护器的各个电流规格参数下的产品组成见图 12-图 20。

The product composition of all current specification parameters of ALP low line protector is shown in Figure 12-Figure 20.



图 12 ALP200-1A、ALP200-5A 产品组成

Figure 12 Product composition of ALP200-1A, ALP200-5A

ALP200 低压线路保护	ALP200 low line protection
100A 以下电流互感器	100a below current transformer
100A 及以下电流互感器选配 (L)	100A and below leakage current transformer selection (L)
XXX/1A 互感器或 XXX/5A 互感器; 用户可自行购买, 也可向我司采购	XXX/1A transformer or XXX/5A transformer; users may purchase by themselves or purchase from our company
A 相, B 相, C 相	A-phase, B-phase, C-phase

注: 1A 需要绕线 5 圈

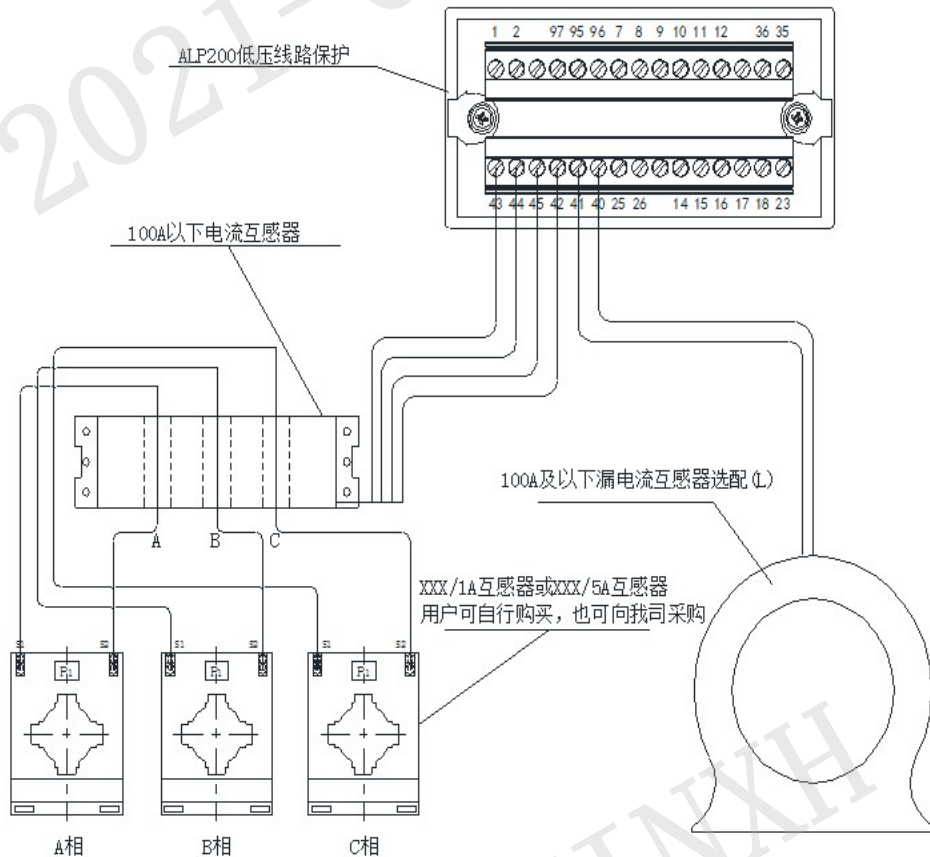
Note: 1A needs to wrap the line for 5 turns.



图 13 ALP200-25A、ALP200-100A 产品组成

Figure 3 Product composition of ALP200-25A, ALP200-100A

25A, 100A 电流互感器	25A, 100A current transformer
ALP200 低压线路保护	ALP200 low line protection
标配长度 1 米	Standard length: 1m
100A 及以下漏电流互感器选配 (L)	100A and below leakage current transformer selection (L)

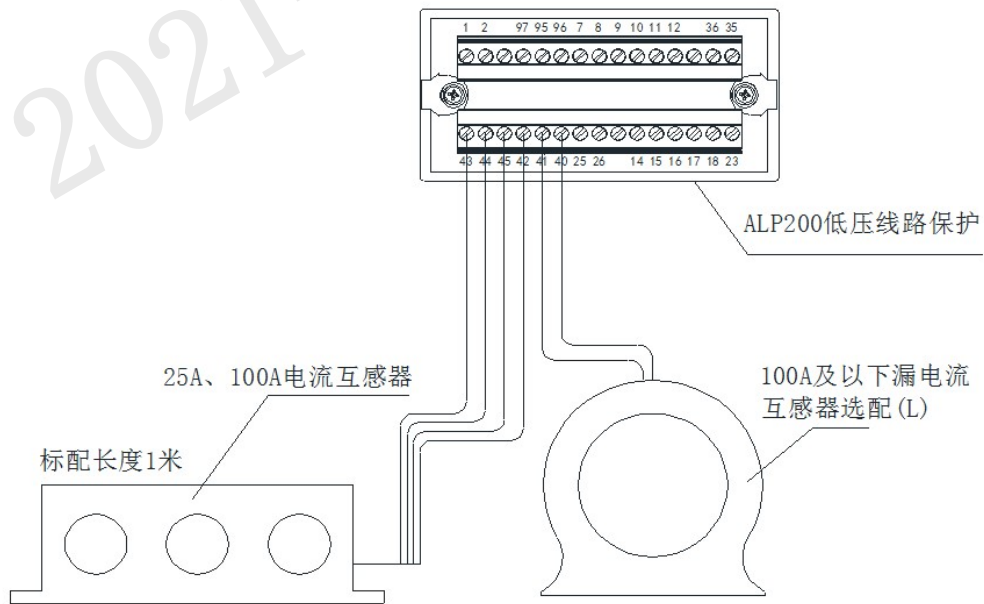

图 14 ALP200-160A、ALP200-400A 产品组成

Figure 14 Product composition of ALP200-160A, ALP200-400A

ALP200 低压线路保护	ALP200 low line protection
标配长度 1 米	Standard length: 1m
100A 以上漏电流互感器选配 (L)	100A and above leakage current transformer selection (L)

电流互感器	Current transformer
A相, B相, C相	A-phase, B-phase, C-phase
零序电流互感器	Zero sequence current transformer

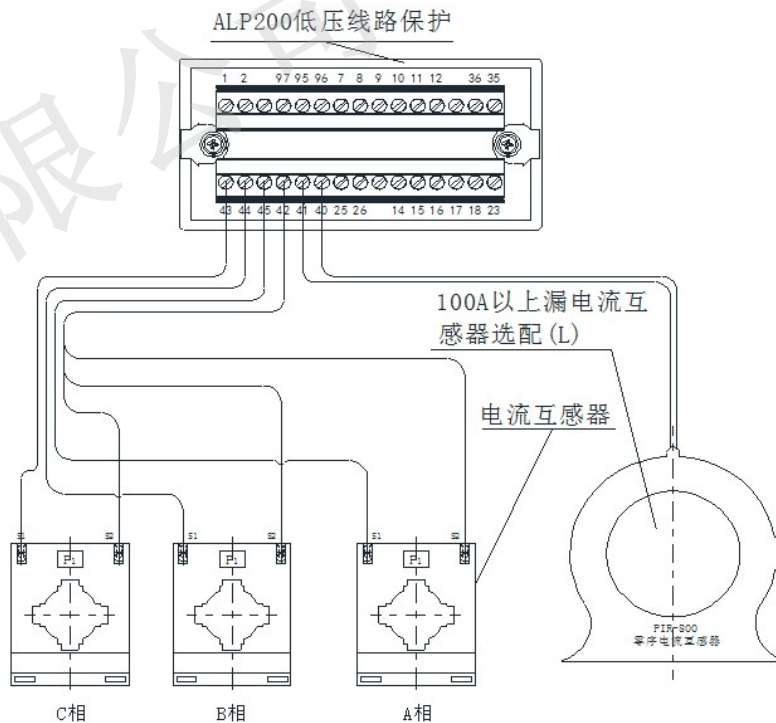

图 15 ALP220-1A、ALP220-5A 产品组成

Figure 15 Product composition of ALP220-1A, ALP220-5A

ALP200 低压线路保护	ALP200 low line protection
1A 穿芯 8 匝, 5A 穿芯 2 匝	1A shall wrap for 8 turns; 5A shall wrap for 2 turns
漏电流互感器	Leakage current transformer
XXX/1A 互感器或 XXX/5A 互感器; 用户可自行购买, 也可向我司采购	XXX/1A transformer or XXX/5A transformer; users may purchase by themselves or purchase from our company
A 相, B 相, C 相	A-phase, B-phase, C-phase

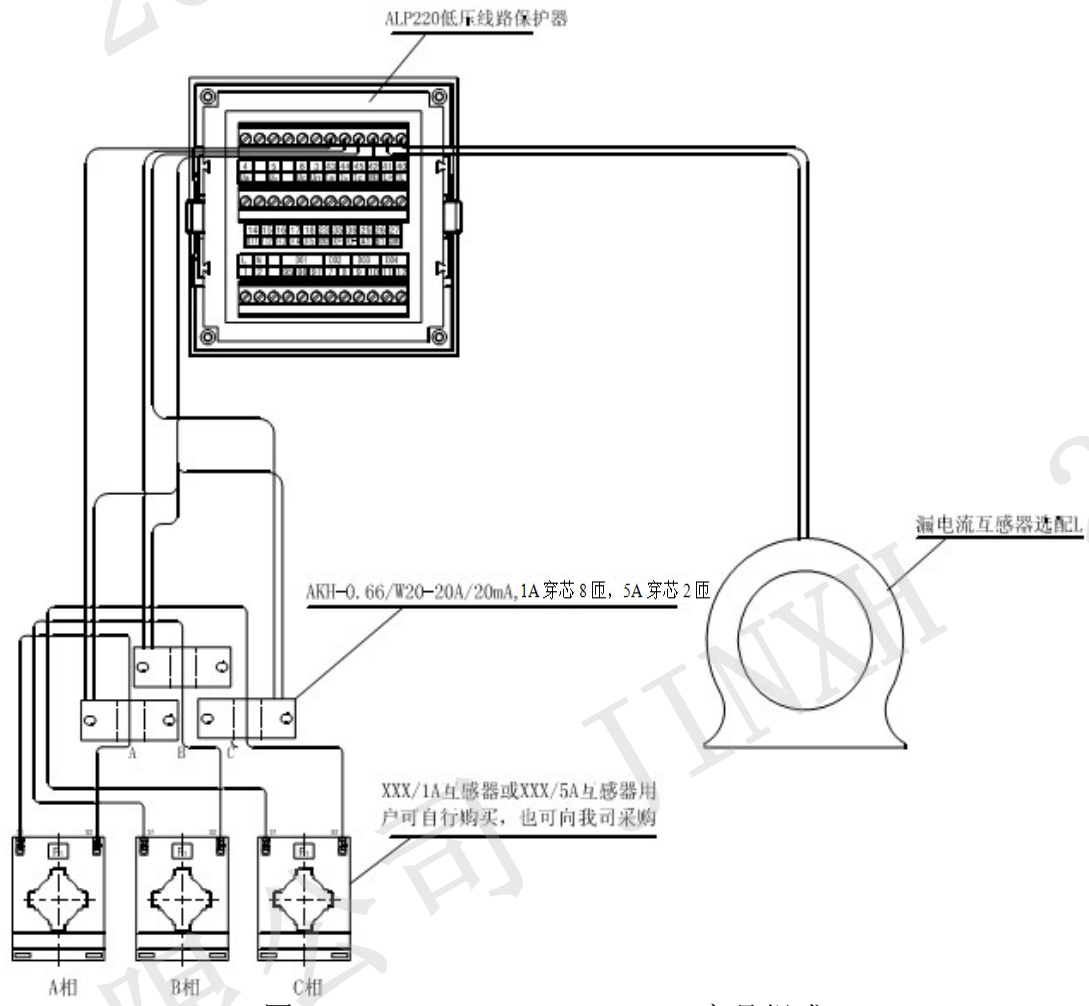

图 16 ALP220-25A、ALP220-100A 产品组成

Figure 16 Product composition of ALP220-25A, ALP220-100A

ALP200 低压线路保护	ALP200 low line protection
25A, 100A 电流互感器 标配长度 1 米	25A, 100A current transformer; standard length: 1m
100A 及以下漏电流互感器选配 (L)	100A and below leakage current transformer selection (L)

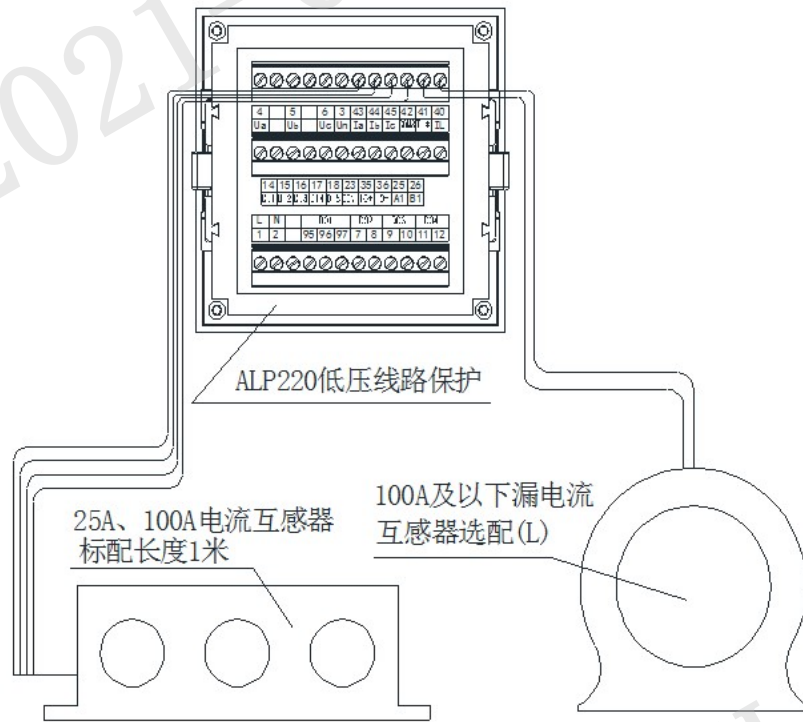

图 17 ALP220-160A、ALP220-400A 产品组成

Figure 17 Product composition of ALP220-160A, ALP220-400A

ALP200 低压线路保护	ALP200 low line protection
100A 及以下漏电流互感器选配 (L)	100A and below leakage current transformer selection (L)
电流互感器, 零序电流互感器	Current transformer, zero sequence current transformer
A 相, B 相, C 相	A-phase, B-phase, C-phase

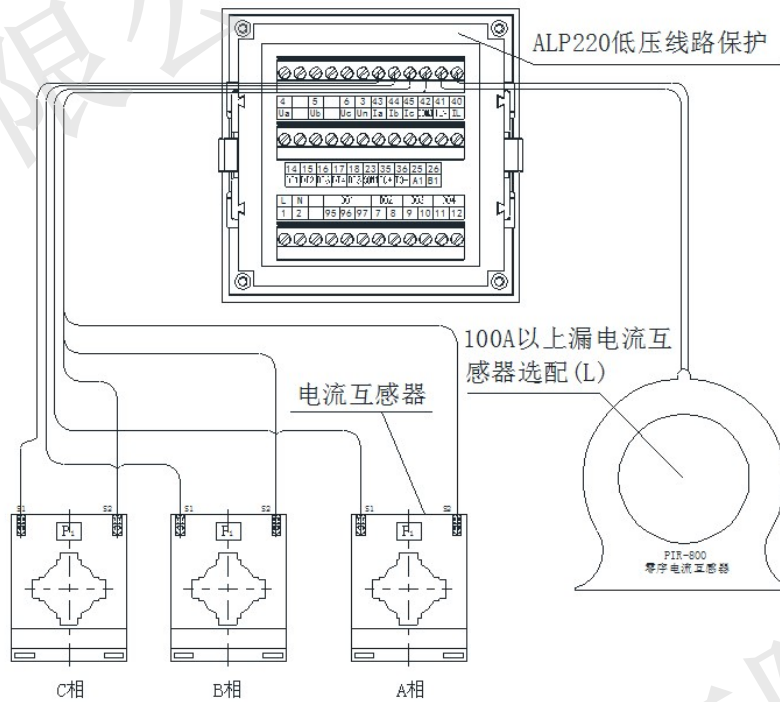

图 18 ALP320-1A、ALP320-5A 产品组成

Figure 18 Product composition of ALP320-1A, ALP320-5A

ALP320 低压线路保护主体模块	Main body module of ALP320 low line protection
液晶显示 90L	LCD 90L
1A 穿芯 8 匝, 5A 穿芯 2 匝	1A shall wrap for 8 turns; 5A shall wrap for 2 turns
漏电流互感器	Leakage current transformer
XXX/1A 互感器或 XXX/5A 互感器; 用户可自行购买, 也可向我司采购	XXX/1A transformer or XXX/5A transformer; users may purchase by themselves or purchase from our company
A 相, B 相, C 相	A-phase, B-phase, C-phase

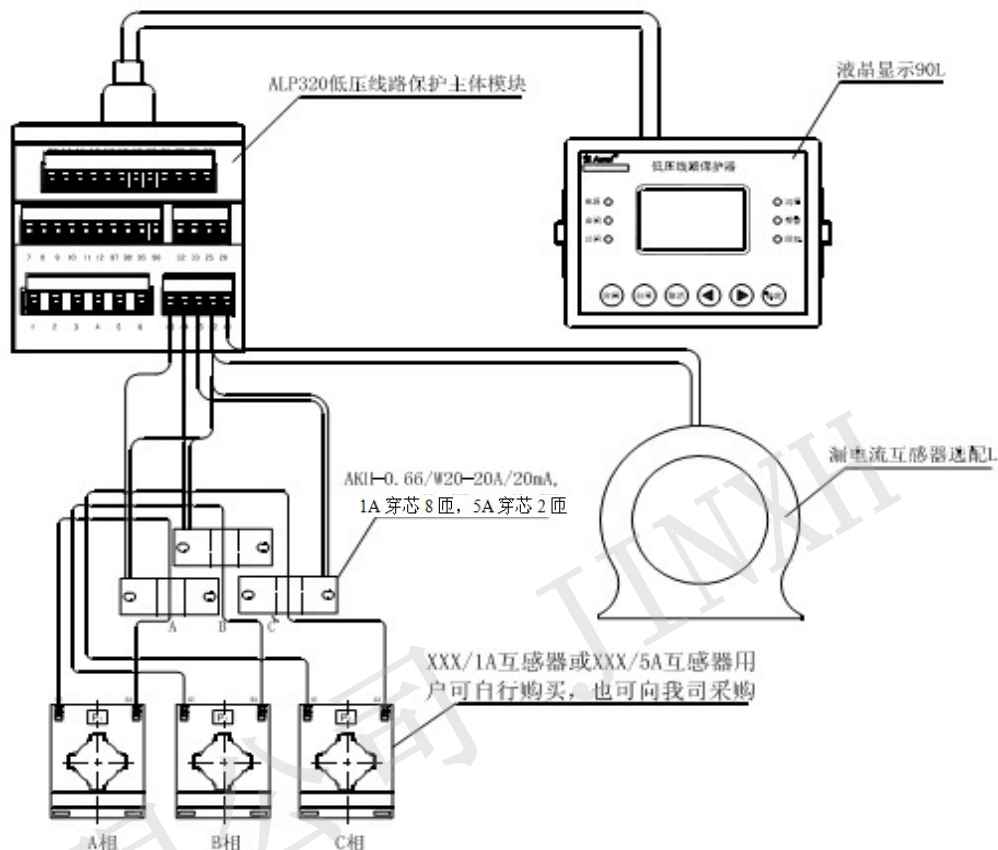

图 19 ALP320-25A、ALP320-100A 产品组成
Figure 19 Product composition of ALP320-25A, ALP320-100A

ALP320 低压线路保护主体模块	Main body module of ALP320 low line protection
液晶显示 90L (选配)	LCD 90L (optional)
25A, 100A 电流互感器 标配长度 1 米	25A, 100A current transformer; standard length: 1m
100A 及以下漏电流互感器选配 (L)	100A and below leakage current transformer section (L)
低压线路保护器	Low line protector

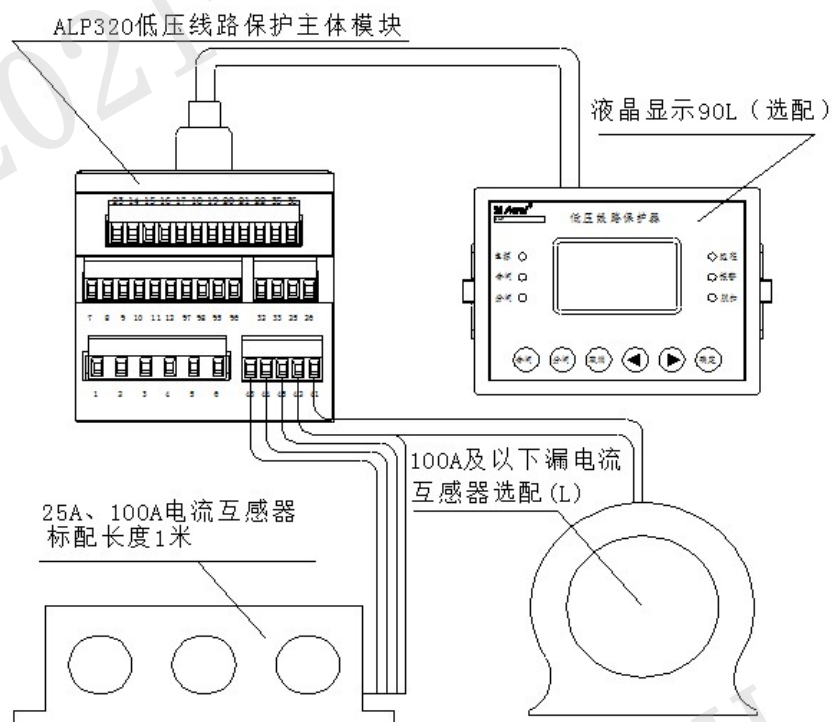

图 20 ALP320-160A、ALP320-400A 产品组成
Figure 20 Product composition of ALP320-160A, ALP320-400A

ALP320 低压线路保护主体模块	Main body module of ALP320 low line protection
液晶显示 90L (选配)	LCD 90L (optional)
100A 及以上漏电互感器选配 (L)	100 and above leakage current transformer selection (L)
低压线路保护器	Low line protector
零序电流互感器	Zero sequence current transformer
电流互感器	Current transformer

7 操作指南 Operation instructions

7.1 显示操作说明 Operating instructions for display

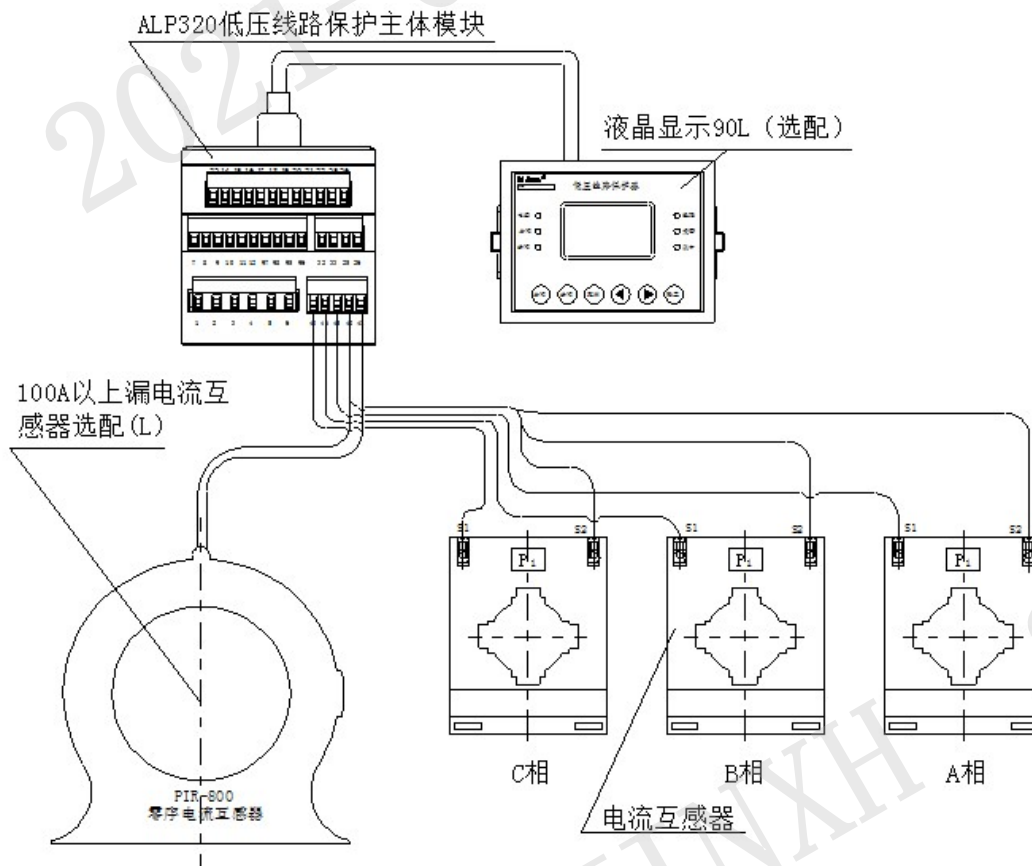
ALP200 显示面板如图 21 所示。

The display panel of ALP200 is shown in Figure 21.



图 21 ALP200 显示面板
Figure 21 Display panel of ALP200

低压线路保护器	Low line protector
电源, 故障, 合闸	Power, failure, closing
取消, 确定	Cancel, confirm

ALP200 显示状态说明、按键功能如表 7 所示。

The display status description and key function of ALP200 are shown in Table 7.

表 7 ALP200 显示状态说明、按键功能
Table 7 Display status description and key function of ALP200

序号 No.	名称 Name	状态 Status	状态或功能说明 Status or function description
1	电源指示灯 Power light	亮/灭 On/off	亮-装置有电, 灭-无电 On-power; off-no-power
2	合闸指示灯 Closing indicator light	亮/灭 On/off	亮-合闸, 灭-分闸 On-closing; off-opening
3	故障指示灯 Fault indicator light	常亮、 灭、闪烁 Normally on/off/flicker	常亮-脱扣, 灭-无脱扣、无报警, 闪烁- 无脱扣, 有报警 Normally on-tripping; off-no tripping; no alarm,
4	“取消”按键 “Cancel” key		无脱扣时: 单击: 退出菜单或取消修改操作。 常按: 不起作用 When there is no tripping: Click: exit the menu or cancel the modification operation. Press: doesn't work 有脱扣时: 单击: 退出菜单或取消修改操作。 常按: 复位 (上电初始界面有效) When there is tripping: Click: exit the menu or cancel the modification operation. Press: reset (The power-on initial interface is effective)
5	左右三角按键 Left and right triangle key		切换显示界面、切换菜单、修改参数 Switch the display interface, switch the menu and modify the parameters
6	“确定”按键 “Confirm” key		进入菜单、保存修改参数 Enter the menu and save the modification parameters

ALP220 显示面板如图 22 所示。

The display panel of ALP220 is shown in Figure 22.



图 22 ALP220 显示面板

Figure 22 Display panel of ALP220

合闸，电源，报警	Closing, power, alarm
低压线路保护器	Low line protector
取消，确定	Cancel, confirm

ALP220 显示状态说明、按键功能如表 8 所示。

The display status description and key function of ALP220 is shown in Table 8.

表 8 ALP220 显示状态说明、按键功能

Table 8 Display status description and key function of ALP220

序号 No.	名称 Name	状态 Status	状态或功能说明 Status or function description
1	电源指示灯 Power light	亮/灭 On/off	亮-装置有电，灭-无电 On-power; off-no-power
2	合闸指示灯 Closing indicator light	亮/灭 On/off	亮-合闸，灭-分闸 On-closing; off-opening
3	分闸指示灯 Opening indicator light	亮/灭 On/off	亮-分闸，灭-合闸 On-opening; off-closing
4	故障指示灯 Fault indicator light	亮/灭 On/off	常亮-脱扣，灭-无脱扣 Normally on-tripping; off-no tripping
5	报警指示灯 Alarm indicator light	亮/灭 On/off	常亮-报警，灭-无报警 Normally on-alarm; off-no alarm
6	DI1-DI5 指示灯 DI1-DI5 indicator light	亮/灭 On/off	亮-对应 DI 导通，灭-对应 DI 不导通 On-corresponding DI is conductive; Off-corresponding DI is not conductive

7	DO1-DO4 指示灯 DO1-DO4 indicator light	亮/灭 On/off	亮-对应 DO 吸合，灭-对应 DO 断开 On-corresponding DO is connected; off-corresponding DO is disconnected
8	“取消”按键 “Cancel” key		无脱扣时： 单击：退出菜单或取消修改操作。 常按：不起作用 When there is no tripping: Click: exit the menu or cancel the modification operation. Press: doesn't work 有脱扣时： 单击：退出菜单或取消修改操作。 常按：复位（上电初始界面有效） When there is tripping: Click: exit the menu or cancel the modification operation. Press: reset (The power-on initial interface is effective)
9	左右三角按键 Left and right triangle key		切换显示界面、切换菜单、修改参数 Switch the display interface, switch the menu and modify the parameters
10	“确定”按键 “Confirm” key		进入菜单、保存修改参数 Enter the menu and save the modification parameters

ALP320 控制器及显示模块面板如图 23 所示。

The ALP320 controller and display module panel are shown in Figure 23.



图 23 ALP320 控制器及显示模块面板

Figure 23 ALP 320 controller and display module panel

低压线路保护器	Low line protector
电源、合闸、分闸、远程、报警、脱扣	Power, closing, opening, remote, alarm, tripping
合闸、分闸、取消、确定	Closing, opening, cancel, confirm
复位	Reset
分闸、合闸、电源、报警、脱扣	Opening, closing, power, alarm, tripping

ALP320 显示状态说明、按键功能如表 9 所示。

The display status description and key function of ALP320 is shown in Table 9.

表 9 ALP320 面板显示状态说明、按键功能
Table 9 Display status description and key function of ALP320

序号 No.	名称 Name	状态 Status	状态或功能说明 Status or function description
1	电源指示灯 Power light	亮/灭 On/off	亮-装置有电, 灭-无电 On-power; off-no-power
2	合闸指示灯 Closing indicatr light	亮/灭 On/off	亮-合闸, 灭-分闸 On-closing; off-opening:
3	分闸指示灯 Opening indicator light	亮/灭 On/off	亮-分闸, 灭-合闸 On-opening; off-closing
4	远程指示灯 Remte indicator light	亮/灭 On/off	亮-控制权限为远程、灭-控制权限为本地 On-the control right is remote; off-the control right is local
5	报警指示灯 Alarm indicator light	亮/灭 On/off	常亮-报警, 灭-无报警 Normally on-alarm; off-no alarm
6	脱扣指示灯 Tripping indicator light	亮/灭 On/off	常亮-脱扣, 灭-无脱扣 Normally on-tripping; off-no tripping
7	“合闸”按键 “Closing” key		权限为本地时, 单击合闸按键执行合闸操作 When the right is local, click the closing key to execute closing operation
8	“分闸”按键 “Opening” key		权限为本地时, 单击分闸按键执行分闸操作 When the right is local, click the opening key to execute opening operation

9	“取消”按键 “Cancel” key	无脱扣时： 单击：退出菜单或取消修改操作。 常按：不起作用 When there is no tripping: Click: exit the menu or cancel the modification operation. Press: doesn't work 有脱扣时： 单击：退出菜单或取消修改操作。 常按：复位（上电初始界面有效） When there is tripping: Click: exit the menu or cancel the modification operation. Press: reset (The power-on initial interface is effective)
10	左右三角按键 Left and right triangle key	切换显示界面、切换菜单、修改参数 Switch the display interface, switch the menu and modify the parameters
11	“确定”按键 “Confirm” key	进入菜单、保存修改参数 Enter the menu and save the modification parameters

7.2 ALP200 及 ALP220 菜单概述 Overview of ALP200 and ALP220 menu

上电后保护器显示屏处于数据显示界面，主界面显示当前线路的分闸、合闸情况以及当前时间及线路最大电流。

After power on, the protector display screen will be on data display interface and the main interface will display the closing and opening condition of current circuit and current time and maximum current of circuit.

13-06-06	09:00:00
分闸 Opening	I _{max} : 0.000A
I _{max} :	0%

按  后进入主菜单。当有故障发生时，主界面显示当前故障。

Press  to enter the main menu. In case of fault, the main interface will display the present fault.

7.2.1 ALP200、ALP220 菜单概述 Overview of ALP200, ALP220 menu

ALP200 及 ALP220 液晶显示菜单为全中文显示。

The ALP200 and ALP220 LCD display menu is all-Chinese display.

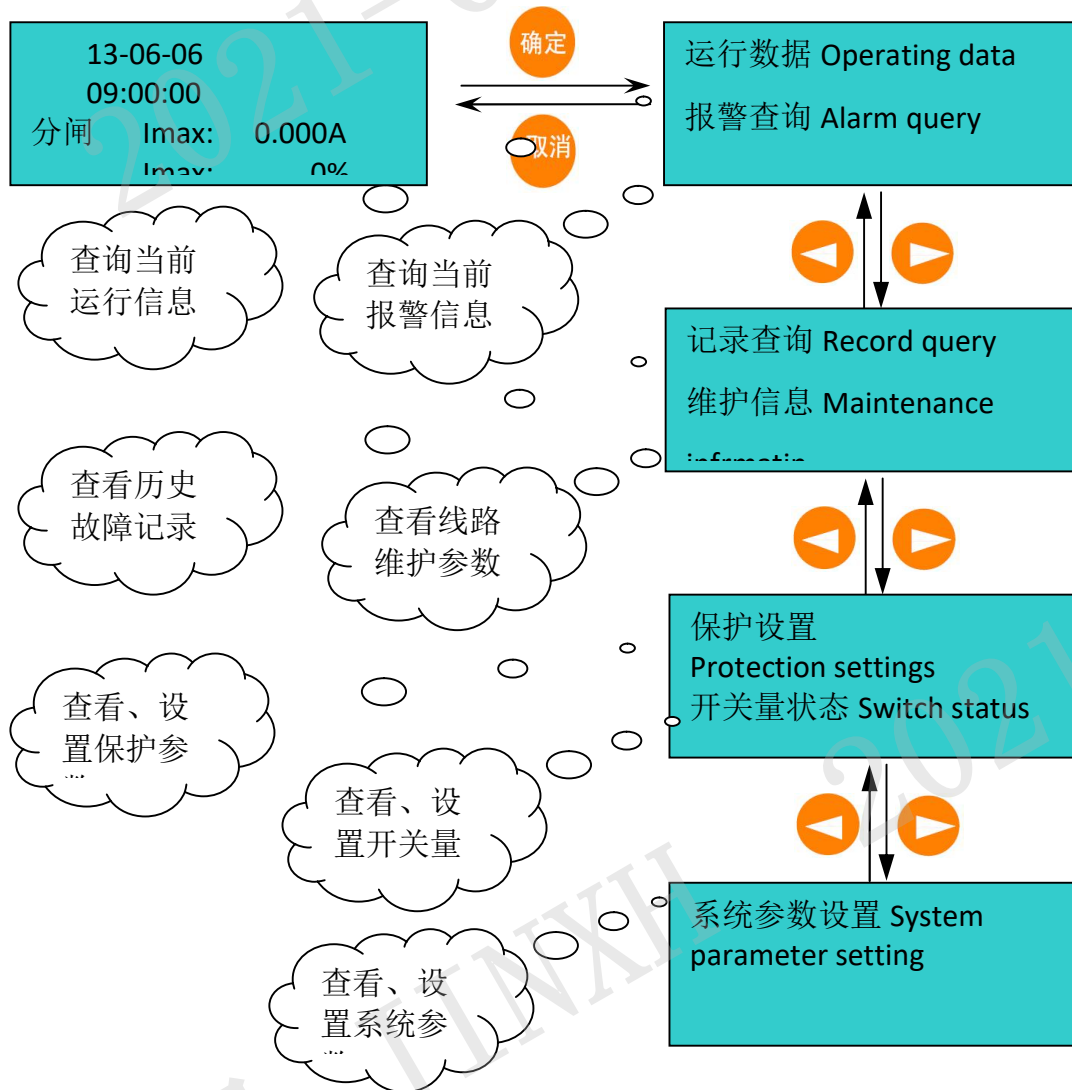

查询当前运行信息	Query the current operating information
查询当前报警信息	Query the current alarm information
查看历史故障记录	Check the historical failure record
查看线路维护参数	Check the line maintenance parameters
查看、设置保护参数	Check and set protection parameters
查看、设置开关量	Check and set analog
查看、设置系统参数	Check and set system parameters

可以操作 按键实现菜单选取和翻页，选中相应菜单后，按 进入对应菜单，按 退出相应菜单。

The menu selection and page turning can be realized by operating key. After selecting the corresponding menu, press to enter corresponding menu, press to exit corresponding menu.

7.2.2 ALP200、ALP220 运行数据菜单 Operating data menu of ALP200, ALP220

ALP200 运行数据菜单 Operating data menu of ALP200:

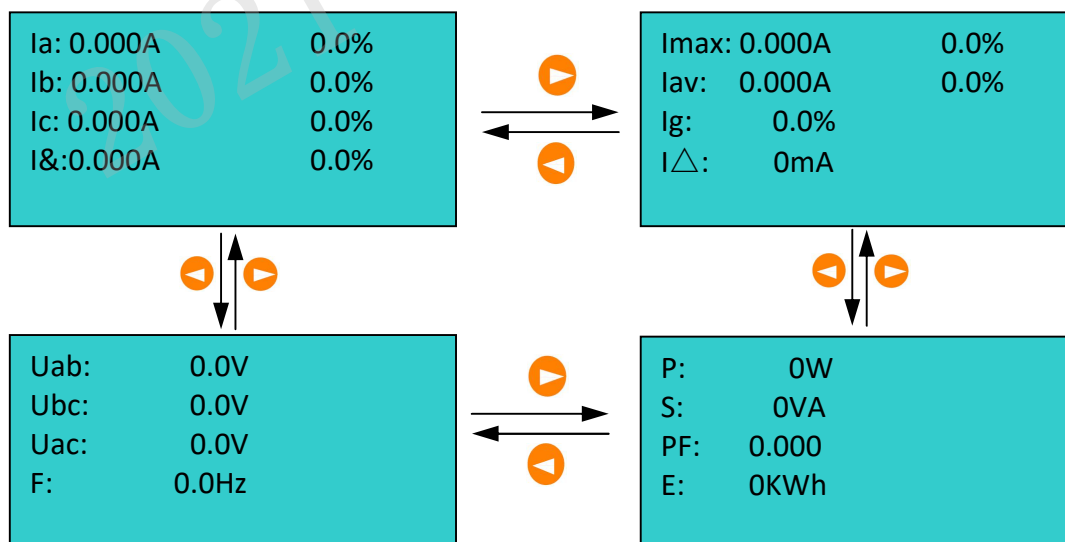

ALP220 运行数据菜单 Operating data menu of ALP220:

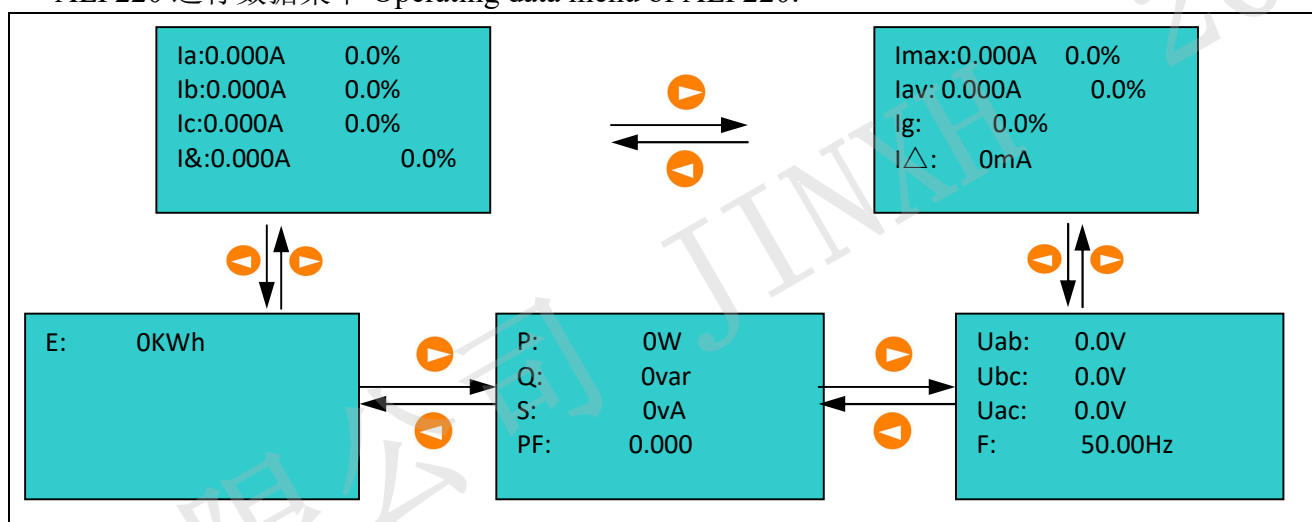





可以操作 按键实现菜单选取和翻页，查看不同的参数显示。注：ALP200 只有电流显示。

The menu selection and page turning can be realized by operating key to check different parameter display. Note: ALP200 only has current display.

7.2.3 ALP200、ALP220 报警信息菜单 Alarm information menu of ALP200, ALP220







反时限过流 反时限零序	无 无	低定时限过流 高定时限过流	无 无	低定时限零序 高定时限零序	无 无
漏电	无	欠压 过压	无 无	联动二 联动三	无 无
断相 不平衡	无 无	电流需量 联动一	无 无		
反时限过流	无	Inverse time over current: no			
反时限零序	无	Inverse zero sequence: no			
低定时限过流	无	Low definite-time over current: no			
高定时限过流	无	High definite-time over current: no			
低定时限零序	无	Low definite-time zero sequence: no			
高定时限零序	无	High definite-time zero sequence: no			
漏电	无	Electric leakage: no			
欠压	无	Unvoltage: no			
过压	无	Overvoltage: no			
联动二	无	Linkage II: no			
联动三	无	Linkage III: no			
电流需量	无	Current demand: no			
联动一	无	Linkage I: no			

可以操作   按键实现报警信息菜单的选取和翻页，查看当前的报警状态显示。





The menu selection and page turning can be realized by operating   key to check the current alarm status display.

7.2.4 ALP200、ALP220 记录查询菜单 Record query menu of ALP200, ALP220

合闸记录 分闸记录	故障记录 DI 动作记录
合闸记录，分闸记录	Closing record, opening record
故障记录，DI 动作记录	Failure record, DI operate record



可以操作   按键实现维护信息菜单的翻页，选中相应菜单后，按  进入对应子菜单，按  退出相应子菜单。进入相应子菜单后，通过操作   按键实现子菜单的翻页，查看对应的故障、维护信息。

The menu selection and page turning can be realized by operating   key. After selecting the



corresponding menu, press  to enter corresponding submenu and press  to exit corresponding submenu. After entering corresponding submenu, operate the   key to realize the page turning of submenu and check corresponding fault and maintenance information.

合闸记录子菜单:

Closing record submenu:





	
xx 合闸 第 8 次 x 年 x 月 x 日 x 时 x 分 x 秒	xx 合闸 第 n 次 x 年 x 月 x 日 x 时 x 分 x 秒
xx 合闸 第 8 次 x 年 x 月 x 日 x 时 x 分 x 秒	Xx closing The 8 th time _D_M_Y_H_M_S
xx 合闸 第 n 次 x 年 x 月 x 日 x 时 x 分 x 秒	Xx closing The n th time _D_M_Y_H_M_S

分闸记录子菜单:

	
xx 分闸 第 8 次 x 年 x 月 x 日 x 时 x 分 x 秒	xx 分闸 第 n 次 x 年 x 月 x 日 x 时 x 分 x 秒
xx 合闸 第 8 次 x 年 x 月 x 日 x 时 x 分 x 秒	Xx closing The 8 th time _D_M_Y_H_M_S
xx 合闸 第 n 次 x 年 x 月 x 日 x 时 x 分 x 秒	Xx closing The n th time _D_M_Y_H_M_S

故障记录子菜单:

Failure record submenu:

	
故障 第 8 次	故障 第 n 次
	
故障详细信息	故障详细信息
故障 第 8 次	Failure: the 8 th time
故障 第 n 次	Failure: the n th time
故障详细信息	Detailed information of failure

DI 动作子菜单:



DI action submenu:



DIx 断开 第 8 次 x 年 x 月 x 日 x 时 x 分 x 秒	DIx 断开 第 n 次 x 年 x 月 x 日 x 时 x 分 x 秒
---	---

Xx 断开 第 8 次 x 年 x 月 x 日 x 时 x 分 x 秒	Xx disconnected The 8 th time _D_M_Y_H_M_S
Xx 断开 第 n 次 x 年 x 月 x 日 x 时 x 分 x 秒	Xx disconnected The n th time _D_M_Y_H_M_S









7.2.5 ALP200、ALP220 维护信息菜单









合闸次数: 2 分闸次数: 1	脱扣次数: 6 总合闸时间: 0h	总分闸时间: 0h
合闸次数: 2 分闸次数: 1	Closing times:2; opening times: 1	
脱扣次数: 6 总合闸时间: 0h	Tripping times: 6; total opening time: 0h	
总分闸时间:0h	Total opening time: 0h	

可以操作   按键实现维护信息菜单的翻页，查看线路运行的维护信息。

The menu selection and page turning can be realized by operating   key to check the line operating maintenance information.

7.2.6 ALP200、ALP220 保护设置菜单 Protection setting menu of ALP200, ALP220

可以操作   按键实现保护设置菜单的翻页，选中相应菜单后，按  进入对应子菜单，按  退出相应子菜单。进入相应子菜单后，通过操作     按键实现子菜单的设置，保护设置菜单中详细设置参数见表 13。

The menu selection and page turning can be realized by operating   key. After selecting the corresponding menu, press  to enter corresponding submenu and press  to exit corresponding submenu. After entering corresponding submenu, operate the     key to realize the setting of submenu. See Table 13 for the detailed setting parameters in protection setting menu.

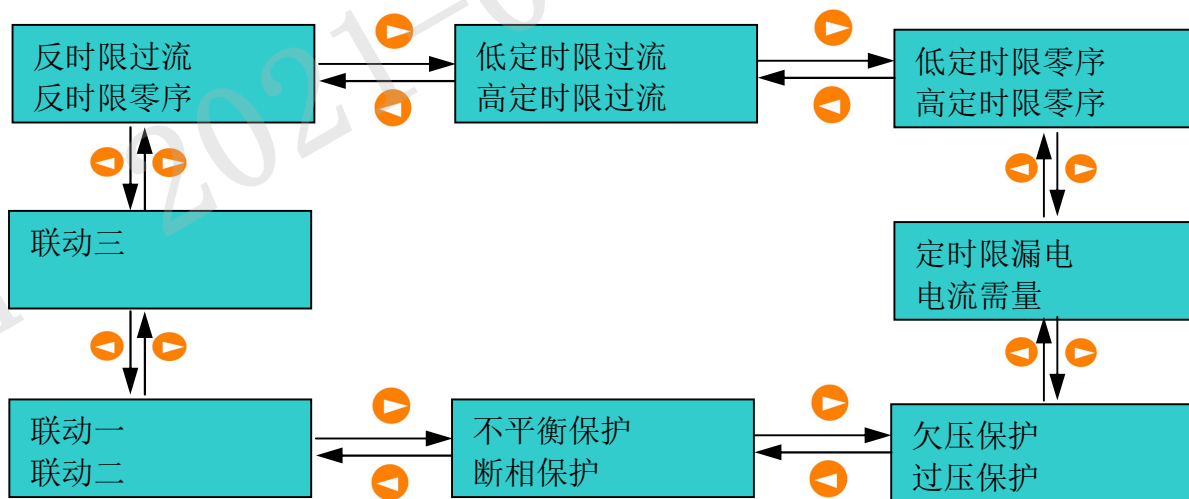

反时限过流 反时限零序	Inverse time over current Inverse zero sequence
低定时限过流 高定时限过流	Low definite-time over current High definite-time over current
低定时限零序 高定时限零序	Low definite-time zero sequence High definite-time zero sequence
联动三	Linkage III
定时限漏电 电流需量	Definite-time leakage Current demand
联动一 联动二	Linkage I Linkage II
不平衡保护 断相保护	Unbalance protection Open phase protection
欠压保护 过压保护	Undervoltage protection Overvoltage protection

7.2.7 ALP200、ALP220 开关量状态菜单 Switch status menu of ALP200, ALP220





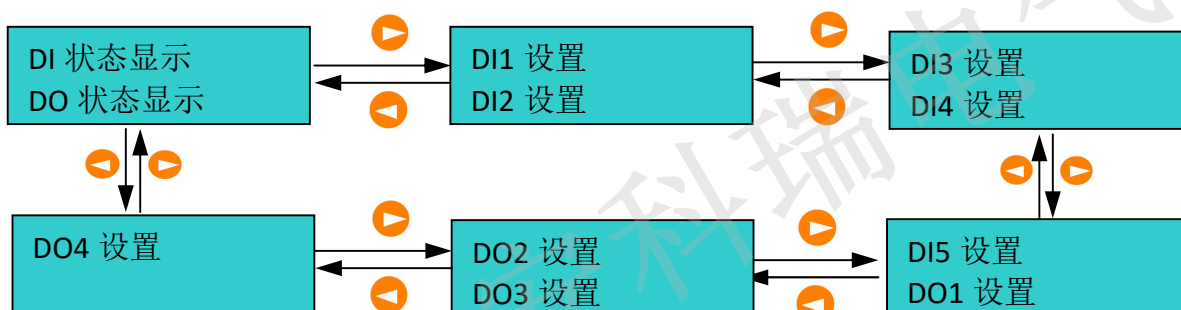



可以操作 按键实现开关量状态菜单的翻页，选中相应菜单后，按 进入对应子菜单，按 退出相应子菜单。进入相应子菜单后，通过操作 按键实现子菜单的设置，开关量状态菜单中详细设置参数见表 14。









The menu selection and page turning can be realized by operating key. After selecting the corresponding menu, press to enter corresponding submenu and press to exit corresponding submenu. After entering corresponding submenu, operate the key to realize the setting of submenu. See Table 14 for the detailed setting parameters in analog status menu.



DI 状态显示 DO 状态显示	Di status display DO status display
DI1 设置 DI2 设置	DI1 setting DI2 setting
DI3 设置 DI4 设置	DI3 setting DI4 setting
DO4 设置	DO4 setting
DO2 设置 DO3 设置	DO2 setting DO3 setting
DI5 设置 DO1 设置	DI5 setting DO1 setting

7.2.8 ALP200、ALP220 系统参数设置菜单 System parameter setting menu of ALP200, ALP220

可以操作   按键实现系统参数设置菜单的翻页，选中相应菜单后，按  进入对应子菜单，按  退出相应子菜单。进入相应子菜单后，通过操作     按键实现子菜单的设置，系统参数设置菜单中详细设置参数见表 15。

The menu selection and page turning can be realized by operating   key. After selecting the corresponding menu, press  to enter corresponding submenu and press  to exit corresponding submenu. After entering corresponding submenu, operate the     key to realize the setting of submenu. See Table 15 for the detailed setting parameters in system parameter menu.

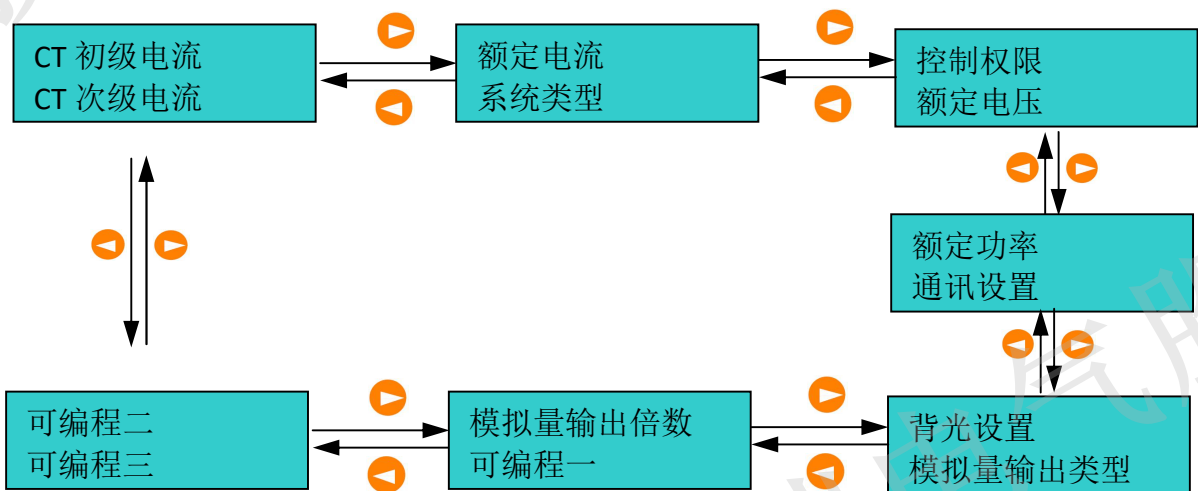

CT 初级电流 CT 次级电流	CT primary current CT secondary current
额定电流 系统类型	Rated current System type
控制权限 额定电压	Control power Rated voltage
额定功率 通讯设置	Rated power Communication setting
可编程二 可编程三	Programmable II Programmable III
模拟量输出倍数 可编程一	Analog output times Programmable I
背光设置 模拟量输出类型	Backlight setting Analog output type

7.3 ALP320 菜单概述 Overview of ALP320 menu

上电后，未按确定键进入设置菜单时，处于数据显示界面，主界面显示当前线路的分、合闸情况以及当前时间及线路最大电流。

After power on, when entering the setting menu without pressing “confirm” key, it will be on the data display interface and the main interface will display the opening and closing condition of current circuit and current time and maximum current of line.

<div style="border: 1px solid black; padding: 5px; background-color: #e0f2f1;"> <p>13-06-06 09:00:00 状态： 分闸 I_{max}: 0.000A</p> </div>	
状态	Status
分闸	Opening

按  后进入主菜单。当有故障发生时，主界面显示当前故障。

Enter the main menu after pressing  key. In case of fault, the main interface will display the current fault.

7.3.1 ALP320 菜单概述 Overview of ALP320 menu

ALP320 液晶显示菜单为全中文显示。

The ALP 320 LCD display menu is all-Chinese.

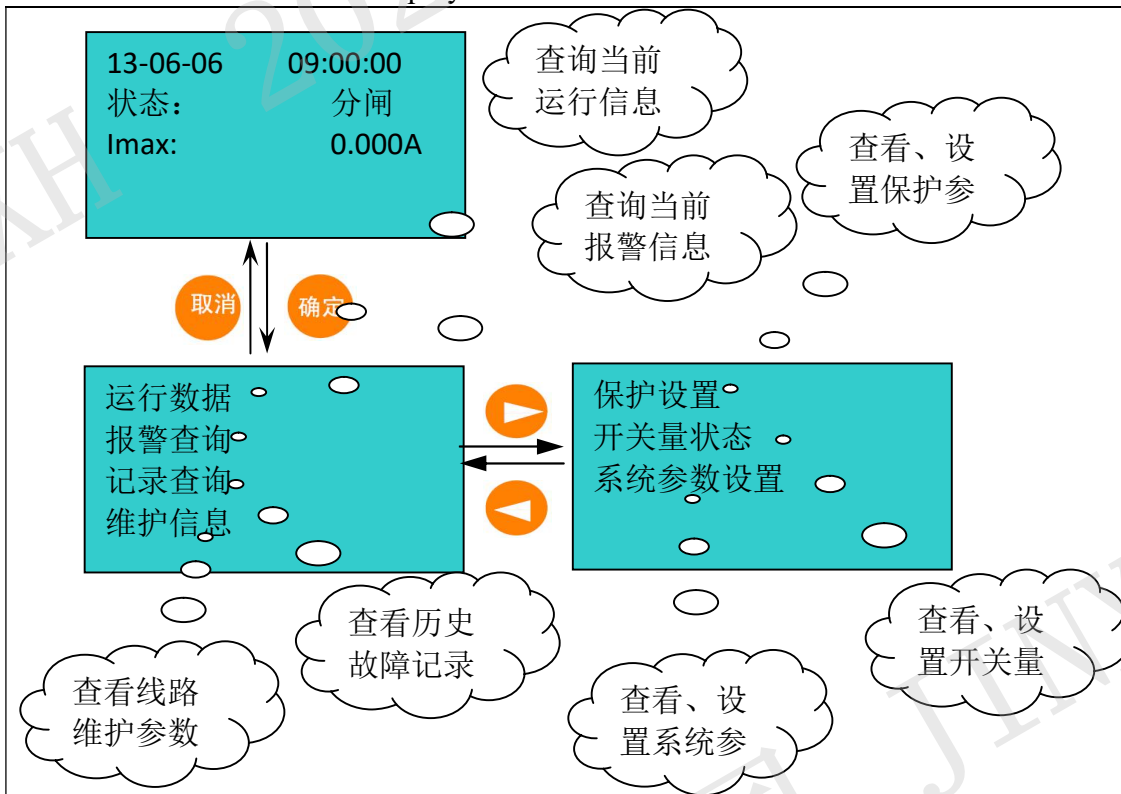

状态: 分闸	Status: opening
查询当前运行信息	Query current operation information
查询当前报警信息	Query current alarm information
查看、设置保护参数	Query and set protection parameters
运行数据 报警查询 记录查询 维护信息	Operating data Alarm query Record query Maintenance information
保护设置 开关量状态 系统参数设置	Protection setting Switch status System parameter setting
查看线路维护参数	Check the line maintenance parameters
查看历史故障记录	Check the historical failure record
查看、设置系统参数	Check and set system parameters
查看、设置开关量	Check and set switch quantity

可以操作 按键实现菜单选取和翻页，选中相应菜单后，按 进入对应菜单，按 退出相应菜单。

The menu selection and page turning can be realized by operating key. After selecting corresponding menu, press to enter corresponding menu and press to exit corresponding menu.

7.3.2 ALP320 运行数据菜单 Operating data menu of ALP320

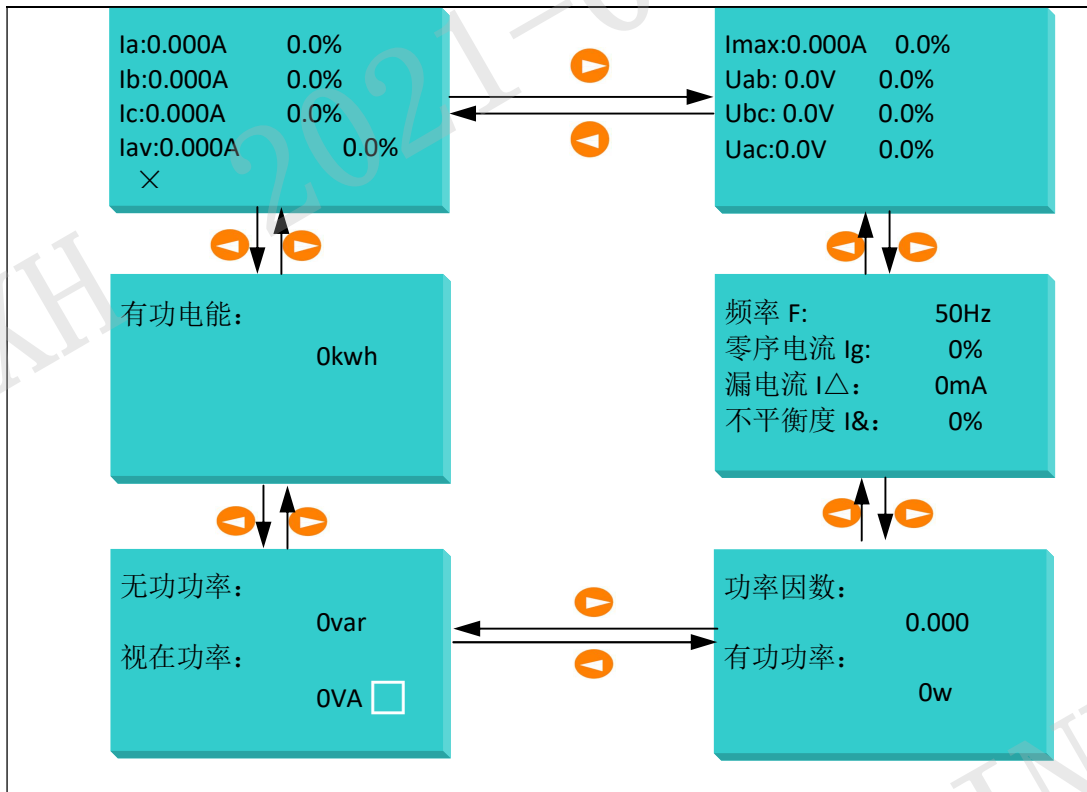

视在功率; 有功电能	Apparent power; active energy
功率因数;有功功率;无功功率	Power factor: active power; reactive power
频率 F: 50Hz 零序电流 Ig: 0% 漏电流 IΔ: 0mA 不平衡度 I&: 0%	Frequency F: Zero sequence current: Leakage current; Unbalance degree:



可以操作 按键实现菜单选取和翻页，查看不同的参数显示。

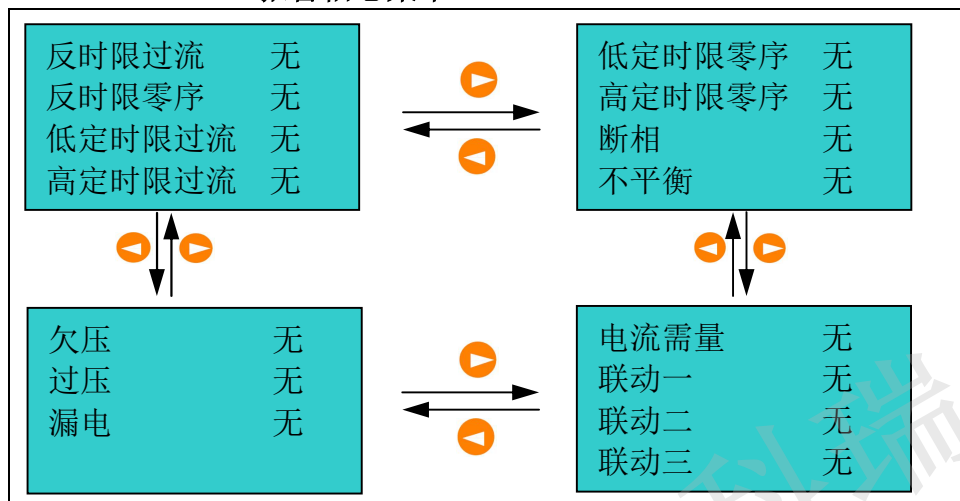

The menu selection and page turning can be realized by operating key to check different parameter display.

7.3.3 ALP320 报警信息菜单 ALP320 alarm information menu



反时限过流	无	Inverse time over current: no
反时限零序	无	Inverse time zero sequence: no
低定时限过流	无	Low definite-time over current: no
高定时限过流	无	High definite-time over current: no
低定时限零序	无	Low definite-time zero sequence: no
高定时限零序	无	High definite-time zero sequence: no
断相	无	Open phase: no
不平衡	无	Unbalance: no
欠压	无	Undervoltage: no
过压	无	Overvoltage: no
漏电	无	Electric leakage: no
电流需量	无	Current demand: no
联动一	无	Linkage I: no
联动二	无	Linkage II: no
联动三	无	Linkage III: no



可以操作   按键实现报警信息菜单的选取和翻页，查看当前的报警状态显示。







The menu selection and page turning can be realized by operating   key to check the current alarm status display.

7.3.4 ALP320 记录查询菜单 ALP320 record query menu

合闸记录
分闸记录
故障记录
DI 动作记录

合闸记录	Closing record
分闸记录	Opening record
故障记录	Failure record
DI 动作记录	DI operate record

可以操作   按键实现维护信息菜单的翻页，选中相应菜单后，按  进入对应子菜单，按  退出相应子菜单。进入相应子菜单后，通过操作   按键实现子菜单的翻页，查看对应的故障、维护信息。

The page turning of maintenance information menu can be realized by operating   key. After selecting corresponding menu, press  to enter corresponding submenu and press  to exit corresponding submenu. After entering corresponding submenu, operate   key to realize the page turning of submenu and check the corresponding fault and maintenance information.

合闸记录子菜单：Closing record submenu:

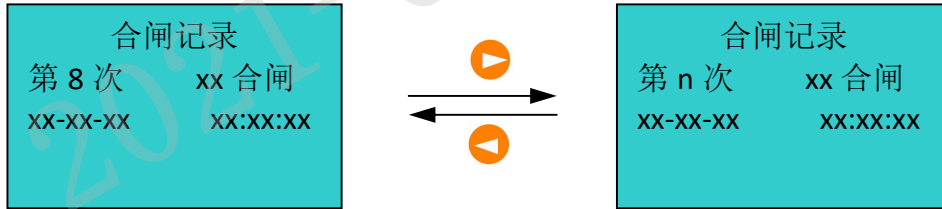

第 8 次	合闸记录 xx 合闸	Closing record The 8 th ; xx closing
第 n 次	合闸记录 xx 合闸	Closing record The n th ; xx closing

分闸记录子菜单：Opening record submenu:

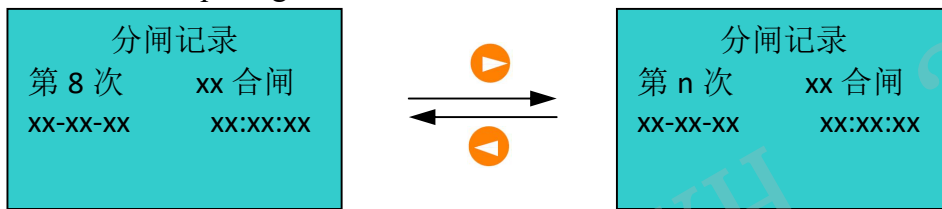

第 8 次	分闸记录 xx 合闸	Opening record The 8 th ; xx closing
第 n 次	分闸记录 xx 合闸	Opening record The n th ; xx closing

故障记录子菜单：Failure record submenu:

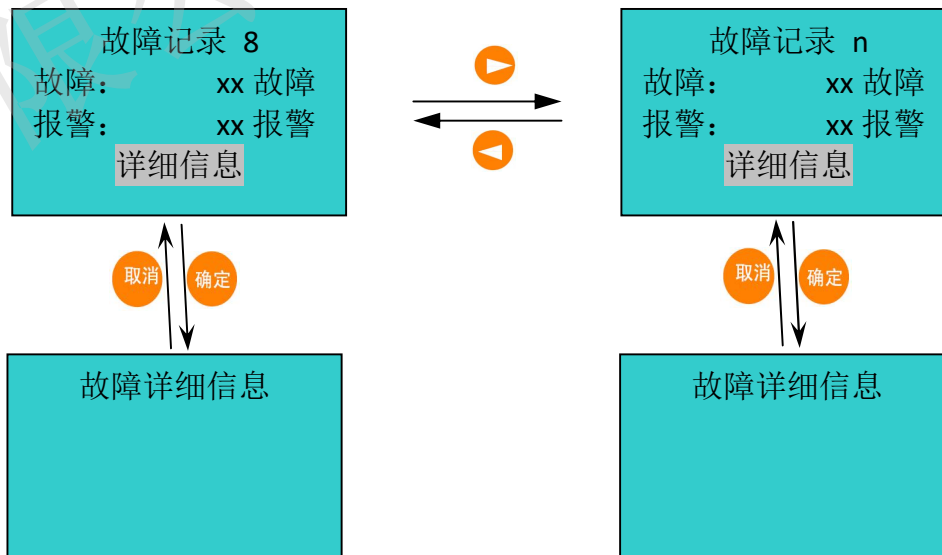

故障记录 8	故障: xx 故障 报警: xx 报警 详细信息	Failure record 8 Failure: xx fault Alarm: xx alarm Detailed information
--------	--------------------------------	--

故障记录 n	Failure record n
故障: xx 故障	Failure: xx fault
报警: xx 报警	Alarm: xx alarm
详细信息	Detailed information
故障详细信息	Detailed information of failure
故障详细信息	Detailed information of failure

DI 动作子菜单: DI action submenu:

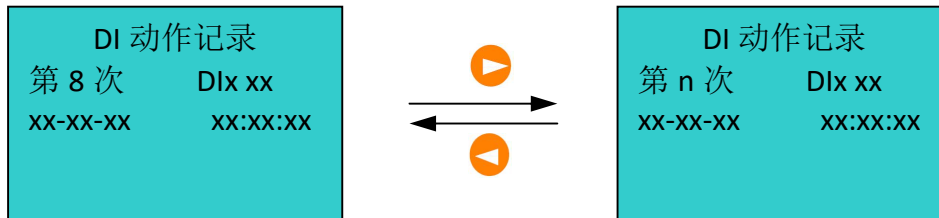

第 8 次	DI 动作记录	DI operate record: the 8 th time
第 n 次	DI 动作记录	DI operate record: the n th time

7.3.5 ALP320 维护信息菜单 ALP320 maintenance information menu

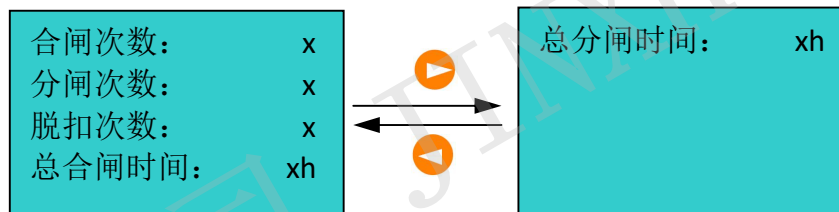

合闸次数: x	Closing times:
分闸次数: x	Opening times:
脱扣次数: x	Tripping times:
总合闸时间: xh	Total opening time
总分闸时间	Total opening time







可以操作 按键实现维护信息菜单的翻页, 查看线路运行的维护信息。

The page turning of maintenance information menu can be realized by operating key to check the operating maintenance information of line.

7.3.6 ALP320 保护设置菜单 ALP320 protection setting menu

可以操作 按键实现保护设置菜单的翻页, 选中相应菜单后, 按 进入对应子菜单, 按 退出相应子菜单。进入相应子菜单后, 通过操作 按键实现子菜单的设置, 保护设置菜单中详细设置参数见表 13。





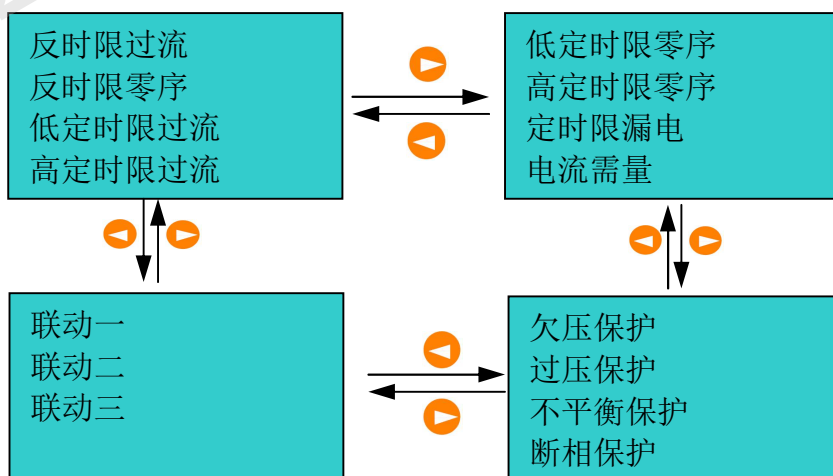



The page turning of protection setting menu can be realized by operating key. After selecting









corresponding menu, press  to enter corresponding submenu and press  to exit corresponding submenu. After entering corresponding submenu, operate     key to realize the submenu setting. See Table 13 for the detailed setting parameters of protection setting menu.



反时限过流 反时限零序 低定时限过流 高定时限过流	Inverse time over current Inverse time zero sequence Low definite-time over current High definite-time over current
低定时限零序 高定时限零序 定时限漏电 电流需量	Low definite-time zero sequence High definite-time zero sequence Definite-time leakage Current demand
联动一 联动二 联动三	Linkage I Linkage II Linkage III
欠压保护 过压保护 不平衡保护 断相保护	Undervoltage protection Overvoltage protection Unbalance protection Open phase protection

7.3.7 ALP320 开关量状态菜单 Switch status menu of ALP320

可以操作   按键实现开关量状态菜单的翻页，选中相应菜单后，按  进入对应子菜单，按  退出相应子菜单。进入相应子菜单后，通过操作     按键实现子菜单的设置，开关量状态菜单中详细设置参数见表 14。

The page turning of switch status menu can be realized by operating   key. After selecting corresponding menu, press  to enter corresponding submenu and press  to exit corresponding submenu. After entering corresponding submenu, operate     key to realize the submenu setting. See Table 14 for the detailed setting parameters of switch status menu.

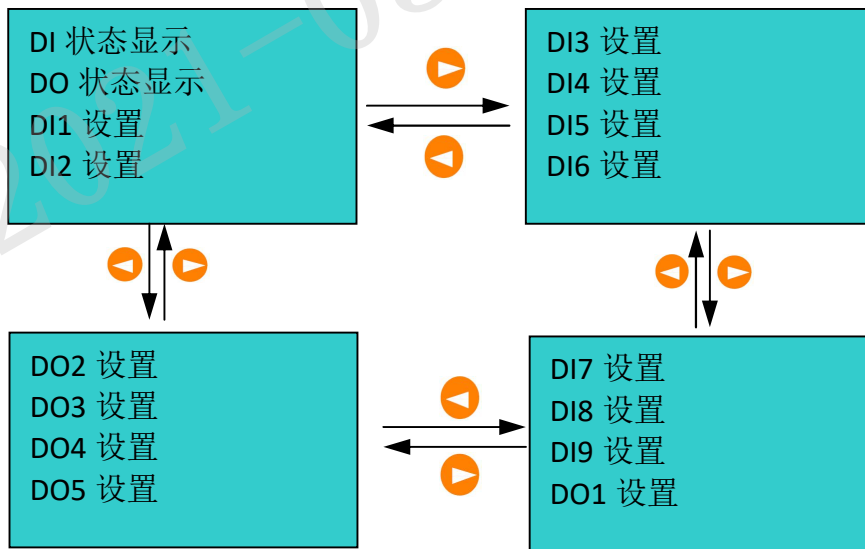

DI 状态显示 DO 状态显示 DI1 设置 DI2 设置	DI status display DO status display DI1 setting DI2 setting
DI3 设置 DI4 设置 DI5 设置 DI6 设置	DI3 setting DI4 setting DI5 setting DI6 setting
DO2 设置 DO3 设置 DO4 设置 DO5 设置	DO2 setting DO3 setting DO4 setting DO5 setting
DI7 设置 DI8 设置 DI9 设置 DO1 设置	DI7 setting DI8 setting DI9 setting DO1 setting

7.3.8 ALP320 系统参数设置菜单 System parameter setting menu of ALP320

可以操作 按键实现系统参数设置菜单的翻页，选中相应菜单后，按 进入对应子菜单，按 退出相应子菜单。进入相应子菜单后，通过操作 按键实现子菜单的设置，系统参数设置菜单中详细设置参数见表 15。

The page turning of system parameter setting menu can be realized by operating key. After selecting corresponding menu, press to enter corresponding submenu and press to exit corresponding submenu. After entering corresponding submenu, operate key to realize

the submenu setting. See Table 15 for the detailed setting parameters of system parameter setting menu.

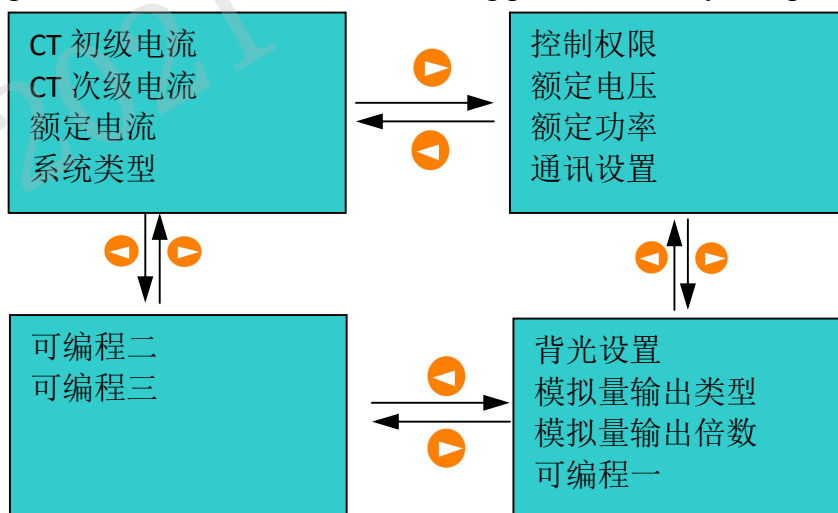

CT 初级电流 CT 次级电流 额定电流 系统类型	CT primary current CI secondary current Rated current System type
控制权限 额定电压 额定功率 通讯设置	Control power Rated voltage Rated power Communication setting
可编程二 可编程三	Programmable II Programmable III
背光设置 模拟量输出类型 模拟量输出倍数 可编程一	Backlight setting Analog output type Analog output times Programmable I

7.4 ALP 各菜单详细描述 Detailed description of all menus of ALP

ALP 系列开关量状态各子菜单内容详述见表 10。

See Table 10 for the detailed submenu contents of ALP series switch status.

表 10 开关量状态菜单详述

Table 10 Specification of switch status menu

菜单 Menu	功能介绍 Function introduction	设置范围 Setting scope	备注 Remarks
------------	-------------------------------	-----------------------	---------------

DI 状态显示 DI status display	显示开关量输入 DI 状态 Display switch input DI status		
DO 状态显示 DO status display	显示开关量输出 DO 状态 Display switch output DO status		
D11-D19 设置 setting Φ	D11-D19 参数设置 parameter setting Φ	DI 状态设置：常开/常闭 DI status setting: normally open/closed DI 编程内容设置： DI programming content setting: 普通 DI； Common DI; 断路器状态； Breaker status; 本地分闸； Local opening; 本地合闸； Local closing; 远程分闸； Remote opening; 远程合闸； Remote closing; 本地、远程选择； Local, remote selection: 联动一； Linkage I; 联动二； Leakage II; 联动三； Linkage III; 复位 Reset	DI 状态默认设置：常开 DI status default setting: normally open D11 编程内容默认设置：断路器状态 D11 programming content default setting: breaker status D12 编程内容默认设置：本地分闸 D12 programming content default setting: local opening D13 编程内容默认设置：本地合闸 D13 programming content default setting: local closing D14 编程内容默认设置：复位 D14 programming content default setting: reset D15 编程内容默认设置：普通 DI D15 programming content default setting: common DI D16 编程内容默认设置：普通 DI D16 programming content default setting: common DI D17 编程内容默认设置：普通 DI D17 programming content default setting: common DI D18 编程内容默认设置：普通 DI D18 programming content default setting: common DI D19 编程内容默认设置：普通 DI Φ D19 programming content default setting: common DI Φ

DO1-DO5 设置 setting ②	DO1-DO5 参数设置 parameter setting ②	DO 模式设置：电平/脉冲 DO mode setting: level/pulse DO 输出设置： DO output setting: 普通 DO； Common DO； 分闸输出； Opening output； 合闸输出； Closing output； 总故障输出； Total fault output； 总报警输出； Total alarm output； 真值表 1 输出； Truth table 1 output； 真值表 2 输出； Truth table 2 output； 真值表 3 输出； Truth table 3 output； 自诊断输出 Self-diagnostic output 脉冲宽度设置：1-5s Pulse width setting: 1-5s	DO1、DO4 模式默认设置：电平 DO1, DO4 mode default setting: level DO2、DO3 模式默认设置：脉冲 DO2, DO3 mode default setting: pulse DO1 默认输出设置：总故障输出 DO1 default output setting: total fault output DO2 默认输出设置：分闸输出 DO2 default output setting: opening output DO3 默认输出设置：合闸输出 DO3 default output setting: closing output DO4 默认输出设置：普通 DO DO4 default output setting: common DO DO5 默认输出设置：普通 DO ② DO5 default output setting: common DO ② 脉冲宽度默认设置：1s Pulse width default setting: 1s
-------------------------	-------------------------------------	---	--

注①：ALP200、ALP220 支持 5 路 DI，ALP320 支持 9 路 DI。

Note ①: ALP200, ALP220 support 5-circuit DI; ALP320 supports 9-circuit DI.

注②：ALP200、ALP220 支持 4 路 DO，ALP320 支持 5 路 DO。

Note ②: ALP200, ALP220 support 4-circuit DO; ALP320 supports 5-circuit DO.

ALP 系列保护设置子菜单内容详述见表 11。

See Table 11 for the detailed ALP series protection setting submenu content.

表 11 保护菜单各子菜单详述

Table 11 Specification of all submenus of protection menu

菜单 Menu	功能介绍 Function introduction	设置范围 Setting scope	备注 Remarks
------------	-------------------------------	-----------------------	---------------

<p>反时限过流保护 Inverse time over current protection</p>	<p>设置反时限过流保护的曲线、冷却时间、动作值、报警值、脱扣、报警、复位方式 Set the protection curve, cooling time, operate value, alarm value, tripping, alarm and reset mode of inverse time over current protection</p>	<p>保护曲线: IEC1、IEC2、IEC3、CO2、CO8、IEEE1、IEEE2、IEEE3 Protection curve: IEC1, IEC2, IEC3, CO2, CO8, IEE1, IEE2, IEE3 冷却时间: 0-30min Cooling time: 0-30min 动作值: 10%-800% Operate value: 报警值: 10%-800% Alarm value: 10%-800% 报警: 允许/禁止 Alarm: allowed/prohibited 脱扣: 允许/禁止 Tripping: allowed/prohibited 复位方式: 手动、自动 Reset mode: manual, automatic 时间系数: 0.025-1.5s Time coefficient: 0.025-1.5s 返回系数: 0.025-3.2s Drop-off to pick-up ratio: 0.025-3.2s</p>	<p>默认值: Default value: 保护曲线: IEC1 Protection curve: IEC1 冷却时间: 5min Cooling time: 5min 动作值: 100% Operate value: 100% 报警值: 85% Alarm value: 85% 报警: 允许 Alarm: allowed 脱扣: 允许 Tripping: allowed 复位方式: 手动 Reset mode: manual 时间系数: 1s Time coefficient: 1s 返回系数: 1s Drop-off to pick-up ratio: 1s</p>
<p>反时限零序保护 Inverse time zero sequence protection</p>	<p>设置反时限零序保护的曲线、冷却时间、动作值、报警值、脱扣、报警、复位方式 Set the protection curve, cooling time, operate value, alarm value, tripping, alarm and reset mode of inverse time zero sequence protection</p>	<p>保护曲线: IEC1、IEC2、IEC3 Protection curve: IEC1, IEC2, IEC3 冷却时间: 0-30min Cooling time: 0-30min 动作值: 10%-800% Operate value: 10%-800% 报警值: 10%-800% Alarm value: 10%-800% 报警: 允许/禁止 Alarm: allowed/prohibited 脱扣: 允许/禁止 Tripping: allowed/prohibited 复位方式: 手动 Reset mode: manual 时间系数: 0.025-1.5s Time factor: 0.025-1.5s</p>	<p>默认值: Default value: 保护曲线: IEC1 Protection curve: IEC1 冷却时间: 5min Cooling time: 5min 动作值: 50% Operate value: 50% 报警值: 20% Alarm value: 20% 报警: 允许 Alarm: allowed 脱扣: 允许 Tripping: allowed 复位方式: 手动 Reset mode: manual 时间系数: 1s Time factor: 1s</p>

<p>低定时限过流保护 Low definite-time over current protection</p>	<p>设置低定时限过流保护的延时时间、保护阈值、报警阈值、返回系数、脱扣、报警 Set the delay time, protection threshold value, alarm threshold value, drop-off to pick-up ratio, tripping and alarm of low definite-time over current protection</p>	<p>延时时间: 0.02-600s Delay time: 0.02-600s 保护阈值: 10%-800% Protection threshold value: 10%-800% 报警阈值: 10%-800% Alarm threshold value: 10%-800% 返回系数: 5%-50% Drop-off to pick-up ratio: 5%-50% 报警: 允许/禁止 Alarm: allowed/prohibited 脱扣: 允许/禁止 Tripping: allowed/prohibited</p>	<p>默认值: Default value: 延时时间: 10s Delay time: 10s 保护阈值: 120% Protection threshold value: 120% 报警阈值: 110% Alarm threshold value: 110% 返回系数: 5 Drop-off to pick-up ratio: 5 报警: 允许 Alarm: allowed 脱扣: 允许 Tripping: allowed</p>
<p>高定时限过流保护 High definite-time over current protection</p>	<p>设置高定时限过流保护的延时时间、保护阈值、报警阈值、返回系数、脱扣、报警 Set the delay time, protection threshold value, alarm threshold value, drop-off to pick-up ratio, tripping and alarm of high definite-time over current protection</p>	<p>延时时间: 0.02-600s Delay time: 0.02-600s 保护阈值: 10%-800% Protection threshold value: 10%-800% 报警阈值: 10%-800% Alarm threshold value: 10%-800% 返回系数: 5%-50% Drop-off to pick-up ratio: 5%-50% 报警: 允许/禁止 Alarm: allowed/prohibited 脱扣: 允许/禁止 Tripping: allowed/prohibited</p>	<p>默认值: Default value: 延时时间: 5s Delay time: 2s 保护阈值: 200% Protection threshold value: 200% 报警阈值: 160% Alarm threshold value: 160% 返回系数: 5 Drop-off to pick-up ratio: 5 报警: 允许 Alarm: allowed 脱扣: 允许 Tripping: allowed</p>

<p>低定时限零序保护 Low definite-time zero sequence protection</p>	<p>设置低定时限零序保护的延时时间、保护阈值、报警阈值、返回系数、脱扣、报警 Set the delay time, protection threshold value, alarm threshold value, drop-off to pick-up ratio, tripping and alarm of low definite-time zero sequence protection</p>	<p>延时时间: 0.02-600s Delay time: 0.02-600s 保护阈值: 10%-800% Protection threshold value: 10%-800% 报警阈值: 10%-800% Alarm threshold value: 10%-800% 返回系数: 5%-50% Drop-off to pick-up ratio: 5%-50% 报警: 允许/禁止 Alarm: allowed/prohibited 脱扣: 允许/禁止 Tripping: allowed/prohibited</p>	<p>默认值: Default value: 延时时间: 0.5s Delay time: 0.5s 保护阈值: 30% Protection threshold value: 30% 报警阈值: 20% Alarm threshold value: 20% 返回系数: 5 Drop-off to pick-up ratio: 5 报警: 允许 Alarm: allowed 脱扣: 允许 Tripping: allowed</p>
<p>高定时限零序保护 High definite-time zero sequence protection</p>	<p>设置高定时限零序保护的延时时间、保护阈值、报警阈值、返回系数、脱扣、报警 Set the delay time, protection threshold value, alarm threshold value, drop-off to pick-up ratio, tripping and alarm of high definite-time zero sequence protection</p>	<p>延时时间: 0.02-600s 保护阈值: 10%-800% Protection threshold value: 10%-800% 报警阈值: 10%-800% Alarm threshold value: 10%-800% 返回系数: 5%-50% Drop-off to pick-up ratio: 5%-50% 报警: 允许/禁止 Alarm: allowed/prohibited 脱扣: 允许/禁止 Tripping: allowed/prohibited</p>	<p>默认值: Default value: 延时时间: 0.5s Delay time: 0.5s 保护阈值: 80% Protection threshold value: 80% 报警阈值: 50% Alarm threshold value: 50% 返回系数: 5 Drop-off to pick-up ratio: 5 报警: 允许 Alarm: allowed 脱扣: 允许 Tripping: allowed</p>

<p>定时限漏电保护 Definite-time leakage protection</p>	<p>设置定时限漏电保护的延时时间、保护阈值、报警阈值、返回系数、脱扣、报警 Set the delay time, protection threshold value, alarm threshold value, drop-off to pick-up ratio, tripping and alarm of definite-time leakage protection</p>	<p>延时时间: 0.02-600s 保护阈值: 30mA-1000mA Protection threshold value: 30mA-1000mA 报警阈值: 30mA-1000mA Alarm threshold value: 30mA-1000mA 返回系数: 5%-50% Drop-off to pick-up ratio: 5%-50% 报警: 允许/禁止 Alarm: allowed/prohibited 脱扣: 允许/禁止 Tripping: allowed/prohibited</p>	<p>默认值: Default value: 延时时间: 50s Delay time: 50s 保护阈值: 100mA Protection threshold value: 100mA 报警阈值: 80mA Alarm threshold value: 80mA 返回系数: 5 Drop-off to pick-up ratio: 5 报警: 允许 Alarm: allowed 脱扣: 允许 Tripping: allowed</p>
<p>电流需量保护 Current demand protection</p>	<p>设置电流需量保护的延时时间、保护阈值、报警阈值、返回系数、脱扣、报警 Set the delay time, protection threshold value, alarm threshold value, drop-off to pick-up ratio, tripping and alarm of current demand protection</p>	<p>延时时间: 1-20min 保护阈值: 10%-800% Protection threshold value: 10%-800% 报警阈值: 10%-800% Alarm threshold value: 10%-800% 返回系数: 5%-50% Drop-off to pick-up ratio: 5%-50% 报警: 允许/禁止 Alarm: allowed/prohibited 脱扣: 允许/禁止 Tripping: allowed/prohibited</p>	<p>默认值: Default value: 延时时间: 5min Delay time: 5min 保护阈值: 120% Protection threshold value: 120% 报警阈值: 110% Alarm threshold value: 110% 返回系数: 5 Drop-off to pick-up ratio: 5 报警: 允许 Alarm: allowed 脱扣: 允许 Tripping: allowed</p>

<p>欠压保护 Undervoltage protection</p>	<p>设置欠压保护的延时时间、保护阈值、报警阈值、返回系数、脱扣、报警 Set the delay time, protection threshold value, alarm threshold value, drop-off to pick-up ratio, tripping and alarm of undervoltage protection</p>	<p>延时时间: 0.02-600s 保护阈值: 45%-90% Protection threshold value: 45%-90% 报警阈值: 45%-90% Alarm threshold value: 45%-90% 返回系数: 5%-50% Drop-off to pick-up ratio: 5%-50% 报警: 允许/禁止 Alarm: allowed/prohibited 脱扣: 允许/禁止 Tripping: allowed/prohibited</p>	<p>默认值: Default value: 延时时间: 5s Delay time: 5s 保护阈值: 80% Protection threshold value: 80% 报警阈值: 90% Alarm threshold value: 90% 返回系数: 5 Drop-off to pick-up ratio: 5 报警: 禁止 Alarm: prohibited 脱扣: 禁止 Tripping: prohibited</p>
<p>过压保护 Overvoltage protection</p>	<p>设置过压保护的延时时间、保护阈值、报警阈值、返回系数、脱扣、报警 Set the delay time, protection threshold value, alarm threshold value, drop-off to pick-up ratio, tripping and alarm of overvoltage protection</p>	<p>延时时间: 0.02-600s 保护阈值: 110%-150% Protection threshold value: 110%-150% 报警阈值: 110%-150% Alarm threshold value: 110%-150% 返回系数: 5%-50% Drop-off to pick-up ratio: 5%-50% 报警: 允许/禁止 Alarm: allowed/prohibited 脱扣: 允许/禁止 Tripping: allowed/prohibited</p>	<p>默认值: Default value: 延时时间: 5s Delay time: 5s 保护阈值: 120% Protection threshold value: 120% 报警阈值: 110% Alarm threshold value: 110% 返回系数: 5 Drop-off to pick-up ratio: 5 报警: 允许 Alarm: allowed 脱扣: 允许 Tripping: allowed</p>

不平衡保护 Unbalance protection	设置不平衡保护的延时时间、保护阈值、报警阈值、返回系数、脱扣、报警 Set the delay time, protection threshold value, alarm threshold value, drop-off to pick-up ratio, tripping and alarm of unbalance protection	延时时间: 0.02-600s 保护阈值: 10%-100% Protection threshold value: 10%-100% 报警阈值: 10%-100% Alarm threshold value: 10%-100% 返回系数: 5%-50% Drop-off to pick-up ratio: 5%-50% 报警: 允许/禁止 Alarm: allowed/prohibited 脱扣: 允许/禁止 Tripping: allowed/prohibited	默认值: Default value: 延时时间: 5s Delay time: 5s 保护阈值: 30% Protection threshold value: 30% 报警阈值: 20% Alarm threshold value: 20% 返回系数: 5 Drop-off to pick-up ratio: 5 报警: 禁止 Alarm: prohibited 脱扣: 禁止 Tripping: prohibited
断相保护 Open-phase protection	设置断相保护的延时时间、脱扣、报警 Set the delay time, tripping and alarm of open-fault protection	延时时间: 0.02-600s Delay time: 0.02-600s 报警: 允许/禁止 Alarm: allowed/prohibited 脱扣: 允许/禁止 Tripping: allowed/prohibited	默认值: Default value: 延时时间: 0.5s Delay time: 0.5s 报警: 允许 Alarm: allowed 脱扣: 允许 Tripping: allowed
联动一、二、三保护 Linkage I, II, III protection	设置联动一、二、三保护的延时时间、脱扣、报警 Set the delay time, tripping and alarm of linkage I, II, III protection	延时时间: 0.06-600s Delay time: 0.06-600s 报警: 允许/禁止 Alarm: allowed/prohibited 脱扣: 允许/禁止 Tripping: allowed/prohibited	默认值: Default value: 延时时间: 5s Delay time: 5s 报警: 禁止 Alarm: prohibited 脱扣: 禁止 Tripping: prohibited

ALP 系列系统参数设置子菜单内容详述见表 12。

See Table 12 for the detailed ALP series system parameter setting submenu content.

表 12 系统参数菜单各子菜单详述

Table 12 Specification of all submenus of system parameter menu

菜单 Menu	功能介绍 Function introduction	设置范围 Setting scope	备注 Remarks
CT 初级电流 CT primary current	设置线路初级电流 Set the primary current of line	1-6300	默认 5 Default: 5
CT 次级电流 CT secondary current	设置线路次级电流 Set the secondary current of line	0、1、5	默认 1, 1A、5A 规格下可设置 Default: 1; it can be set under 1A, 5A specification

额定电流 Rated current	设置线路额定电流 Set the rated current of line	1-6300	
系统类型 System type	设置系统类型 Set system type	单相、三相三线、三相四线 Single phase, three-phase three-wire, three-phase four-wire	默认三相四线 Default: three-phase four-wire
控制权限 Control power	设置控制器控制权限 Set the control power of controller	全控、三选一、禁止、本地、远方、本地/远方、通讯、本地/通讯、远方/通讯、 All control, one out of three, prohibited, local, remote, local/remote, communication, local/communication, remote/communication	默认：全控 Default: all-control
额定电压 Rated voltage	设置线路额定电压 Set the rated voltage of line	110-1200V	默认：380V Default: 380V
额定功率 Rated power	设置线路额定功率 Set the rated power of line		
通讯设置 Communication setting	设置保护器的通讯方式 Set the communication mode of protector	通讯地址：1-247 Communication address: 1-247 波特率：2400, 4800, 9600, 19200, 38400 Baud rate: 2400, 4800, 9600, 19200, 38400 奇偶校验：无校验, 奇校验, 偶校验 Odd-even check: no parity check, odd parity check 停止位：1 个停止位, 2 个停止位 Stop bit: 1 stop bit; 2 stop-bit	通讯地址默认值：1 Default value of communication address: 1 波特率默认值：19200 Default value of Baud rate: 19200 奇偶校验默认值：无校验 Default value of odd-even check: no parity check 停止位默认值：1 个停止位 Default value of stop bit: 1 stop bit
背光设置 Backlight setting	设置保护器液晶背光显示方式 Set the LCD backlight display mode of protector	常亮、自动 Normally on, automatic	默认：常亮 Default: Normally on
模拟量输出类型 Analog output type	设置保护器模拟量输出的控制类型 Set the control type of protector analog output	Ia, Ib, Ic, Iav, Imax, Uab, Ubc, Uac, P, F	默认：Iav, 注：ALP200 只有 Ia、Ib、Ic、Iav、Imax 可设置 Default: Iav; Note: ALP200 only has Ia, Ib, Ic, Iav, Imax to set
模拟量输出倍数 Analog output times	设置保护器模拟量输出的控制类型的倍数 Set the times of control type of protector analog output	电流：1-8；电压：1-2；功率：1-8；频率：65Hz Current: 1-8; voltage: 1-2; power: 1-8; frequency: 65Hz	默认：2 Default: 2

<p>可编程一、二、三 Programmable I, II, III</p>	<p>设置可编程的参数 Set programmable parameters</p>	<p>类型：关闭;A;A*B; Type: closed; A;A*B; A+B;A*B*C;(A+B)*C; A*B+C;A+B+C A、B、C：无输入；反时限过流；低定 时限过流；高定时限过流；低定 时限零序；高定时限零序；反 时限零序；断相；不平衡； 电流需量；联动 1；联动 2； 联动 3；欠压；过压；定 时限漏电； DI1;DI2;DI3; DI4;DI5;DI6;DI7;DI8;DI9 A, B, C: no input: inverse time over current; low definite-time over current; high definite-time over current; low definite-time zero sequence; high definite-time zero sequence; open phase; unbalance; current demand; linkage 1; linkage 2; linkage 3; undervoltage; overvoltage; definite-time leakage; DI1;DI2;DI3; DI4;DI5;DI6;DI7;DI8;DI9</p>	<p>可编程一类型默认值： A Default value of programmable I type: A 可编程二类型默认值： A×B Default value of programmable II type: A×B 可编程三类型默认值： A+B Default value of programmable III type: A+B 可编程一 A、B、C 默认值： 反时限过流、低定 时限过流、高定 时限过流 Default value of programmable I A, B, C: inverse time over current, low definite-time over current, high definite-time over current 可编程二 A、B、C 默认值： 低定 时限零序、高定 时限零序、反 时限零序 Default value of programmable II A, B, C: low definite-time zero sequence, high definite-time zero sequence, inverse time zero sequence 可编程三 A、B、C 默认值： 断相、不 平衡、电 流需量 Default value of programmable III A, B, C: open phase, unbalance, current demand</p>
---	---	---	--

变送设置举例：

Example of transmission setting:

变送类型设置为 Iav，变送倍率为 2，表示测量电流 Iav 为 0 时变送输出 4mA 直流信号，测量电流为 2 倍额定电流时输出 20mA，变送类型 Ia、Ib、Ic 与此相同。

Set the transmission type as Iav, transmission rate as 2. It means that when the current Iav is 0, it will transmit and output 4mA direct current; when the current is 2-times rated current, it will output 20mA. The transmission type Ia, Ib, Ic is the same.

7.5 ALP 保护功能介绍 Introduction of ALP protection function

■高定时限过流保护 High definite-time over current protection

高定时限过流保护，通过对三相电流的监测，实现保护功能。

High definite-time over current protection can realize protection function through monitoring the three-phase current.

高定时限过流保护投入可选择脱扣或报警，当高定时限过流保护功能模块监测到线路运行电流达到或超过“高定时限过流保护动作值”时，高定时限过流保护报警或脱扣启动并计时，在设定的脱扣时间内发出报警或脱扣命令。

Tripping or alarm can be selected for high definite-time over current protection input. When the high definite-time over current protection module monitors that the line running current reaches or exceeds “high definite-time over current protection operate value”, the high definite-time over current protection alarm or tripping will start and time and give out alarm or tripping command within set tripping time.

■低定时限过流保护 Low definite-time over current protection

低定时限过流保护，通过对三相电流的监测，实现保护功能。

Low definite-time over current protection can realize protection function through monitoring the three-phase current.

低定时限过流保护投入可选择脱扣或报警，当低定时限过流保护功能模块监测到线路运行电流达到或超过“低定时限过流保护动作值”时，低定时限过流保护报警或脱扣启动并计时，在设定的脱扣时间内发出报警或脱扣命令。

Tripping or alarm can be selected for low definite-time over current protection input. When the low definite-time over current protection module monitors that the line running current reaches or exceeds “low definite-time over current protection operate value”, the low definite-time over current protection alarm or tripping will start and time and give out alarm or tripping command within set tripping time.

■反时限过流保护 Inverse time over current protection

反时限过流保护共有 8 簇反时限特性曲线可供选择，通过对三相电流的监测，实现保护功能。

8 clusters of inverse time characteristic curves can be selected for inverse time over current protection and it can realize protection function through monitoring the three-phase current.

反时限过流保护时间特性：

Inverse time overcurrent protection time characteristics:

$$t = T_p \times \left(\frac{K}{\left(\frac{I}{I_s}\right)^\alpha - 1} + L \right)$$

其中：Where:

t = 跳闸时间 tripping time

K = 系数（见表）coefficient (See Table)

I = 电流测量值 Measured current value

I_s = 程序设定的门限值 Threshold value set by program

α = 系数（见表）coefficient (See Table)

L = ANSI/IEEE 系数（对 IEC 曲线为 0）ANSI/IEEE coefficient (it is 0 for IEC curve)

T_p = 1，时间因子 time factor

表 13 反时限过流保护曲线动作特性

Table 13 Curve operating characteristics of inverse time over current protection

特性序号 Character istic No.	特性类型 Characteris tic type	标准 Standard	K 因子 K factor	α 因子 α factor	L 因子 L factor
IEC1	标准反时限 Standard inverse time	IEC	0.14	0.02	0

IEC2	非常反时限 Abnormal inverse time	IEC	13.5	1	0
IEC3	极端反时限 Extreme inverse time	IEC	80	2	0
CO2	短时反时限 Short-time inverse time	CO2	0.00342	0.02	0.00242
CO8	长时反时限 Long-time inverse time	CO8	5.95	2	0.18
IEEE1	中度反时限 Moderate inverse time	ANSI/IEEE	0.0515	0.02	0.114
IEEE2	非常反时限 Abnormal inverse time	ANSI/IEEE	19.61	2	0.491
IEEE3	极端反时限 Extreme inverse time	ANSI/IEEE	28.2	2	0.1215

反时限过流保护复位时间特性：

Reset time characteristic of inverse time over current protection:

IEC1、IEC2、IEC3 复位特性：

IEC1, IEC2, IEC3 reset characteristic:

反时限过流保护动作前：

Before inverse time over current protection action:

当三相电流回复到 $I < I_s$ 时返回。

Return when three-phase current is back to $I < I_s$.

反时限过流保护动作后：

After inverse time over current protection action:

报警在故障原因消失后返回。

The alarm will return after fault cause disappears.

脱扣保持，脱扣复位通过复位键或者接收到复位命令复位。

Tripping holding, tripping reset will reset through reset key or receiving reset command.

适用于 CO2、CO8、IEEE1、IEEE2、IEEE3 复位特性：

It is applicable to CO2, CO8, IEEE1, IEEE2, IEEE3 reset characteristics:

适用于这 5 中曲线的复位特性是：

The reset characteristic applicable to the five curves is:

$$t = Tre \times \left(\frac{K}{1 - (I/I_s)^\alpha} \right)$$

其中：Where:

t = 复位时间 reset time

K = 系数（见表）coefficient (See table)

I = 电流测量值 Measured current value

I_s = 程序设定的门限值（起动值）Threshold value set by program (starting value)

α = 系数（见表） coefficient (See table)

$T_{re} = 1$, 复位时间因子 reset time factor

表 14 反时限过流保护曲线复位特性

Table 14 Curve reset characteristic of inverse time over current protection

特性序号 Characteristic No.	特性类型 Characteristic type	标准 Standard	K 因子 K factor	α 因子 α factor
CO2	短时反时限 Short-time inverse time	CO2	0.323	2
CO8	长时反时限 Long-time inverse time	CO8	5.95	2
IEEE1	中度反时限 Moderate inverse time	ANSI/IEEE	4.85	2
IEEE2	非常反时限 Abnormal inverse time	ANSI/IEEE	21.6	2
IEEE3	极端反时限 Extreme inverse time	ANSI/IEEE	29.1	2

反时限过流保护动作前:

Before inverse time over current protection action:

当三相电流回复到 $I < I_s$ 时, 按复位公式返回。

When three-phase current is back to $I < I_s$, return by reset formula.

反时限过流保护动作后:

After inverse time over current protection action:

报警在报警条件消失后返回。

Alarm will return after alarm conditions disappear.

脱扣保持, 脱扣复位通过复位键或者接收到复位命令复位。

Tripping keeping, tripping reset will reset through reset key or receiving reset command.

■高定时限零序保护 High definite-time zero sequence protection

高定时限零序保护投入可选择脱扣或报警, 当高定时限零序保护功能模块监测到零序电流达到或超过“高定时限零序保护动作值”时, 高定时限零序保护报警或脱扣启动并计时, 在设定的脱扣时间内发出报警或脱扣命令。

Tripping or alarm can be selected for high definite-time zero sequence protection input. When the high definite-time zero sequence protection module monitors that the zero sequence current reaches or exceeds “high definite-time zero sequence protection operate value”, the high definite-time zero sequence protection alarm or tripping will start and time and give out alarm or tripping command within set tripping time.

■低定时限零序保护

低定时限零序保护投入可选择脱扣或报警, 当低定时限零序保护功能模块监测到零序电流达到或超过“低定时限零序保护动作值”时, 低定时限零序保护报警或脱扣启动并计时, 在设定的脱扣时间内发出报警或脱扣命令。

Tripping or alarm can be selected for low definite-time zero sequence protection input. When the low definite-time zero sequence protection module monitors that the zero sequence current reaches or exceeds “low definite-time zero sequence protection operate value”, the low definite-time zero sequence protection alarm or tripping will start and time and give out alarm or tripping command within set tripping time.

■反时限零序保护 Inverse zero sequence protection

反时限零序保护一共有 3 簇反时限特性可供选择，选择其中一簇，通过对零序电流的监测，实现保护功能。

Altogether 3-cluster inverse time characteristics can be selected for inverse time zero sequence protection. Select one of them to realize the protection function through monitoring the zero sequence current.

反时限零序保护时间特性：

Time characteristics of inverse time zero sequence protection:

$$t = TpE \times \left(\frac{K}{\left(\frac{I}{Ise}\right)^\alpha - 1} \right)$$

其中：Where:

- t = 跳闸时间 tripping time
- K = 系数（见表）coefficient (See table)
- I = 电流测量值 measured current value
- Ise = 程序设定的起动值 starting value set by program
- α = 系数（见表）coefficient (See table)
- TpE= 1，整定的时间系数 set time coefficient

表 15 低设定定时限零序保护特性参数

Table 15 Characteristic parameters of low definite-time zero sequence protection

特性序号 Characteristic No.	特性类型 Characteristic type	标准 Standard	K 因子 K factor	α 因子 α factor
IEC1	标准反时限 Standard inverse time	IEC	0.14	0.02
IEC2	非常反时限 Abnormal inverse time	IEC	13.5	1
IEC3	极端反时限 Extreme inverse time	IEC	80	2

返回值：Return value:

反时限零序保护报警起动后，延时结束前，电流回复到 $I < Ise$ 时返回，

It will return after inverse time zero sequence protection alarm starts before delay finishes and current is back to $I < Ise$;

反时限零序保护脱扣动作后，按复位键复位。

Press reset key to reset after inverse time zero sequence protection tripping action.

■断相/不平衡保护 Open-fault/unbalance protection

断相/不平衡故障运行时对线路的危害很大，当线路发生断相或三相电流严重不平衡时，如不平衡率达到保护设定值时，保护器按照设定的要求保护，发出跳闸或报警，确保线路的安全运行。

It will cause huge harm to line if it operates in open-fault-unbalance fault. In case of serious unbalance of open phase or three-phase current of line, if the unbalance rate reaches the protection set value, the protector will give out tripping or alarm according to the set requirements so as to make sure of the safe operation of line.

三相不平衡率计算公式为： $|I-I_{av}|/IX$ ， I_{av} 为三相电流平均值，当 I_{av} 小于 I_e 时，分母 $IX = I_e$ ；当 I_{av} 大于 I_e 时，分母 $IX = I_{av}$ 。

The calculation formula for three-phase unbalance rate is: $|I-I_{av}|/IX$; I_{av} is the average value of three-phase current; when I_{av} is less than I_e , the denominator $IX = I_e$; when I_{av} is larger than I_e , the denominator $IX = I_{av}$.

■漏电保护 Leakage protection

漏电保护是通过增加漏电互感器，以检测出故障电流，主要用于非直接接地的保护，以保证人身安全。

Leakage protection is to detect the fault current through adding leakage transformer. It is mainly used for indirect grounding protection to guarantee the personal safety.

■需量保护 Demand protection

采用滑差方式计算需量电流，时间窗口固定为 1min，动作特性：

Adopt slip frequency to calculate the demand current and the time window is fixed as 1min. The operating characteristic is as follows:

- (1) 需量电流大于 1.1 倍设定值持续 1min 后，发出报警信号，达到或超过设定的延时时间后，执行脱扣；When the demand current is larger than 1.1-time set value and lasts for 1min, it will give out alarm signal; after reaching or exceeding set delay time, it will execute tripping;
- (2) 发生过 1 次需量保护，重新合闸后，一段时间内，需量电流仍大于等于 1.1 倍设定值，延时 1min 后发出报警信号，经 3min 后脱扣。Once demand protection occurs. After re-closing, if the demand current is still larger than or equal to 1.1-time set value over a period of time, it will give out alarm signal after delay for 1min and tripping after 3 min.
- (3) 发生过 2 次需量保护，重新合闸后，一段时间内，需量电流仍大于等于 1.1 倍设定值，延时 1min 后发出报警信号，经 2min 后脱扣，脱扣后须经 30min 冷却后才能执行复位。Twice demand protection occurs. After re-closing, if the demand current is still larger than or equal to 1.1-time set value over a period of time, it will give out alarm signal after delay for 1min and tripping after 2 min. After tripping, it will execute reset after 30min cooling.
- (4) 在首次执行需量脱扣后，若一段时间内，没有再次发生需量保护，同时，经过此段时间后，若再次发生需量保护，则应重新执行（1）-（3）过程。After executing demand tripping for the first time, if there is no demand protection within a period of time and if demand protection occurs again after the period of time, re-execute (1)-(3) process.

■欠压保护 Undervoltage protection

当线路电压低于设定的欠电压保护值时，保护器按设定的要求进行保护，在动作设定时间内动作或报警。

When the line voltage is lower than set undervoltage protection value, the protector will take protection

according to set requirements and give out action or alarm within action setting time.

■过压保护 Overvoltage protection

当线路电压超过设定的保护电压时，保护器按设定的要求进行保护，在动作设定时间内动作或报警，以保证线路安全。

When the line voltage exceeds the set protection voltage, the protector will take protection according to set requirements and give out action or alarm within action setting time so as to guarantee the line safety.

■联动保护 Linkage protection

以设置为联动保护的开关量输入点作为联动输入点，联动信号长于延时时间，执行脱扣/报警。

Take the switch input point set as linkage protection as linkage input point and execute tripping/alarm when the linkage signal is longer than delay time.

8 通讯 Communication

8.1 Modbus RTU 通信协议概述 Overview of Modbus RTU communication protocol

电气接口：RS485 半双工

Electrical interface: RS485 half-duplex

波特率：2400/4800/9600/19200/38400

Baud rate: 2400/4800/9600/19200/38400

地址：由一个字节组成（8 位二进制），十进制为 0~255，系统中只使用 1~247，其它保留

Address: It is composed of one byte (8-digit binary) and decimal is 0-255. Only 1-247 is used in the system and the others remain.

错误检测：CRC

Error detection: CRC

数据格式	地址码 Address code	功能码 Function code	数据区 Data area	CRC 校验 CRCcheck
------	---------------------	----------------------	------------------	--------------------

Data format: :

数据长度:	1 个字节 1 byte	1 个字节 1 byte	N 字节 N byte	2 个字节 2 bytes
-------	-----------------	-----------------	----------------	------------------

每字节位：1 位起始位、8 位数据位（最小有效位先发送）、无奇偶校验、1 位停止位

Each byte bit: 1 start bit, 8 data bits (the least significant bit will be sent firstly), no odd-even check, 1 stop bit.

ALP 系列支持的 modbus 功能码:

Modbus function code supported by ALP series:

03 (0x03) 功能码: 读保持寄存器

03 (0x03) function code: read holding registers

06 (0x06) 功能码: 写单个保持寄存器

06 (0x06) function code: write single holding register

16 (0x10) 功能码: 写多个保持寄存器

16 (0x10) function code: write several holding registers

注：运行控制位、输出控制位使用 16 功能码写入。

Note: Operating control bit, output control bit use 16-function code to write in.
 通讯应用

Communication application

本节所举实例尽可能采用下表格式（数据为 16 进制）

The examples taken in the section shall adopt the format of following table as much as possible (the data is hex system).

Addr	Fun	Data start		Data		CRC16	
		reg Hi	reg Lo	reg Hi	reg Lo	Lo	Hi
01H	03H	00H	00H	00H	06H	C5H	C8H
地址 Address	功能码 Function code	数据起始地址 Data initial address		数据读取个数 Data read number		循环冗余校验码 CRC code	

读数据 Read data

例 1：使用 03 功能读寄存器：读取 247 号 ALP，从地址 00 开始读 3 个数据

Example 1: use 03 function read register to read No.247 ALP and start reading 3 data from address 00.

查询数据 Query data 帧 frame	F7 03 00 00 00 03 11 5D
返回数据 Return data 帧 frame	F7 03 06 00 00 00 00 00 0E D1

说明：Description:

F7: 从机地址

F7: Slave address

03: 功能码

03: Function code

06: 十六进制，十进制为 6，表示后面有 6 个字节的数据

06: hexadecimal, decimal is 6, meaning that it has 6-byte data behind.

0E D1: 循环冗余校验码

0E D1: CRC code

8.2 ALP 系列通讯地址表 ALP series communication address table

ALP 系列详细 MODBUS 通讯地址见表 16 所示。

See Table 16 for the detailed MODBUS communication address of ALP series.

表 16 ALP 系列通讯地址表

Table 16 ALP series communication address table

地址 Address	名称 Name	范围 Scope	属性 Attribute	数据格式 Data format	备注 Remarks
0	A 相电流 A-phase current	0-10000	R	Word	
1	B 相电流 B-phase current	0-10000	R	Word	

2	C 相电流 C-phase current	0-10000	R	Word	
3	平均电流 Average current	0-10000	R	Word	
4	最大电流 Maximum current	0-10000	R	Word	
5	A 相电流与额定电流百分比 Percentage of A-phase current and rated current	0-1000	R	Word	
6	B 相电流与额定电流百分比 Percentage of B-phase current and rated current	0-1000	R	Word	
7	C 相电流与额定电流百分比 Percentage of C-phase current and rated current	0-1000	R	Word	
8	平均电流与额定电流百分比 Percentage of average current and rated current	0-1000	R	Word	
9	最大电流与额定电流百分比 Percentage of maximum current and rated current	0-1000	R	Word	
10	剩余电流/接地电流 Residual current/grounding current	0-1000	R	Word	
11	漏电流 Leakage current		R		
12	输入输出状态 Input and output status		R		Bit0~Bit4: DI(输入)1~5; Bit8~Bit11: DO(输出)1~4。 (输入: 0-断, 1-通; 输出: 1—吸合, 0—断开) Bit0~Bit4: DI(input)1~5; Bit8~Bit11: DO(output)1~4. (input: 0-off, 1-on; output: 1—closing, 0—disconnected)
13	控制权限 Control power		R		bit0-本地, bit1-远程, bit2-通讯, bit3-三选一 bit0-local, bit1-remote, bit2-communication, bit3-one out of three

14	基本故障 Basic fault		R	<p>Bit0: 反时限过流; Bit1: 低定时限过流; Bit2: 高定时限过流; Bit3: 低定时限零序; Bit4: 高定时限零序; Bit5: 反时限零序; Bit6: 断相; Bit7: 不平衡; Bit8: 电流需量保护; Bit9: 联动 1; Bit10: 联动 2; Bit11: 联动 3 (0-没有, 1-有)</p> <p>Bit0: inverse time over current; Bit1: low definite-time over current; Bit 2: high definite-time over current; Bit 3: low definite-time zero sequence; Bit4: high definite-time zero sequence; Bit5: inverse time zero sequence; Bit6: open phase; Bit 7: unbalance; Bit 8: current demand protection; Bit9: linkage 1; Bit10: linkage 2; Bit 11: linkage 3 (0-no; 1-yes)</p>
15	扩展故障 Expansion fault		R	<p>Bit0: 欠压; Bit1: 过压; Bit2: 定时限漏电 (0-没有, 1-有)</p> <p>Bit0: undervoltage; Bit1: overvoltage; Bit2: definite-time leakage (0-no, 1-yes)</p>
16	基本报警 Basic alarm		R	<p>Bit0: 反时限过流; Bit1: 低定时限过流; Bit2: 高定时限过流; Bit3: 低定时限零序; Bit4: 高定时限零序; Bit5: 反时限零序; Bit6: 断相; Bit7: 不平衡; Bit8: 电流需量保护; Bit9: 联动 1; Bit10: 联动 2; Bit11: 联动 3 (0-没有, 1-有)</p> <p>Bit0: inverse time over current; Bit1: low definite-time over current; Bit 2: high definite-time over current; Bit 3: low definite-time zero sequence; Bit4: high definite-time zero sequence; Bit5: inverse time zero sequence; Bit6: open phase; Bit 7: unbalance; Bit 8: current demand protection; Bit9: linkage 1; Bit10: linkage 2; Bit 11: linkage 3 (0-no; 1-yes)</p>

17	扩展报警 Expansion alarm		R		Bit0: 欠压; Bit1: 过压; Bit2: 定时限漏电 (0-没有, 1-有) Bit0: undervoltage; Bit1: overvoltage; Bit2: definite-time leakage (0-no, 1-yes)
18	电流比例因子 Current sense ratio		R		直接显示小数点位数 1、2、3 Directly display decimal place 1, 2, 3
19	电流不平衡度 Current unbalanced degree		R		
20	AB 电压百分比 AB voltage percentage		R	Word	
21	BC 电压百分比 BC voltage percentage		R	Word	
22	CA 电压百分比 CA voltage percentage		R	Word	
23	AB 电压 AB voltage		R	Word	
24	BC 电压 BC voltage		R	Word	
25	CA 电压 CA voltage		R	Word	
26	视在功率低位 Apparent power low order		R	Word	
27	视在功率高位 Apparent power high order		R		
28	有功功率符号位 Active power sign bit		R		11 代表为负 11 represents negative
29	有功功率低位 Active power low bit		R	Word	
30	有功功率高位 Active power high bit		R		
31	功率因数 Power factor		R	Word	
32	电能低 Low electric energy		R		
33	电能高 High electric energy		R		
34	无功功率低位 Reactive power low bit		R		
35	无功功率高位 Reactive power high bit		R	Word	
36	频率 Frequency		R	Word	

37	线路状态 Line status		R		线路状态,bit0-故障状态, 1-故障, 0-没有故障; bit1-分合闸, 1-合闸, 0-分闸 Line status,bit0-failure state, 1-fault, 0-no fault; bit1-opening and closing, 1-closing, 0-opening
38	可编程输出结果 Programmable output result				bit0-可编程 1; bit1-可编程 2; bit3 可编程 3。(1-有输出, 0-无输出) bit0- programmable 1; bit1-programmable 2; bit3 programmable 3. (1-output, 0-no output)
39-50	预留 Reserved				
51	DO 控制 DO control		W		Bit0,1-DO1;Bit2,3-DO2;Bit4,5-DO3;Bit6,7-DO4;Bit8,9-DO5
52	分合闸控制 Opening/closing control		W		Bit0、1-合闸, Bit2、3-分闸, Bit3、4 复位。11 触发命令, 00 待命 Bit0, 1-closing, Bit2, 3-opening, Bit3, 4 reset. 11 trigger orders, 00 await orders
53-60	预留 Reserved				
62	总合闸次数 Total closing times		R		
63	总分闸次数 Total opening times		R		
64	总故障脱扣次数 Total fault tripping times		R		
65	总合闸时间 Total closing time		R		
66	总分闸时间 Total opening time		R		
67	版本号 Version number				x.yz
68-80	预留 Reserved				
81	实时时钟年月 Real-time clock, year, month		R/W		
82	实时时钟日时 Real-time clock, day, hour		R/W		
83	实时时钟分秒 Real-time clock, minute, second		R/W		
84-99	预留 Reserved				

100	CT 初级电流 CT primary current	1~6300	R/W		1~6300
101	CT 次级电流 CT secondary current	0、1、5	R/W		1/5 有此功能 1/5 has such function
102	额定电流 Rated current		R/W		1~6300
103	系统类型 System type	0-1	R/W		0=1p,1=3p4,2=3p3
104	反时限过流保护曲线 Inverse time over current protection curve	0	R/W		0-IEC1;1-IEC2;2-IEC3;3-CO2;4-CO8;5-IEEE1;6-IEEE2;7-IEEE3
105	反时限过流保护冷却时间 Inverse time over current protection cooling time	0-30	R/W		0~120
106	反时限零序保护曲线 Inverse time zero sequence protection curve	0	R/W		0-IEC1;1-IEC2;2-IEC3
107	反时限零序保护冷却时间 Inverse time zero sequence protection curve	0-30	R/W		0~120
108	保护复位方式 Protection reset mode	0-3	R/W		Bit0-反时限过流保护复位方式; Bit1-外部联锁保护复位方式。0-手动, 1-自动 Bit0-inverse time over current protection reset mode; Bit1-external linkage protection reset mode. 0-manual, 1-automatic
109	控制权限 Control power	0-15	R/W		bit0-本地, bit1-远程, bit2-通讯, bit3-三选一 bit0-local, bit1-remote, bit2-communication, bit3-one out of three

110	基本保护脱扣使能 Basic protection tripping enabling	0-2047	R/W	<p>Bit0: 反时限过流; Bit1: 低定时限过流; Bit2: 高定时限过流; Bit3: 低定时限零序; Bit4: 高定时限零序; Bit5: 反时限零序; Bit6: 断相; Bit7: 不平衡; Bit8: 电流需量保护; Bit9: 联动 1; Bit10: 联动 2; Bit11: 联动 3 (0-禁止, 1 允许)</p> <p>Bit0: inverse time over current; Bit1: low definite-time over current; Bit2: high definite-time over current; Bit3: low definite-time zero sequence; Bit4: high definite-time zero sequence; Bit 5: inverse time zero sequence; Bit6: open phase; Bit7: unbalance; Bit8: current demand protection; Bit9: linkage 1; Bit10: linkage 2; Bit11: linkage 3 (0-prohibited; 1-allowed)</p>
111	扩展保护脱扣使能 Expansion protection tripping enabling	0-2047	R/W	<p>Bit0: 欠压; Bit1: 过压; Bit2: 定时限漏电 (0-禁止, 1 允许)</p> <p>Bit0: undervoltage; Bit1: overvoltage; Bit2: definite-time leakage (0-prohibited, 1-allowed)</p>
112	基本保护报警使能 Basic protection alarm enabling	0-2047	R/W	<p>Bit0: 反时限过流; Bit1: 低定时限过流; Bit2: 高定时限过流; Bit3: 低定时限零序; Bit4: 高定时限零序; Bit5: 反时限零序; Bit6: 断相; Bit7: 不平衡; Bit8: 电流需量保护; Bit9: 联动 1; Bit10: 联动 2; Bit11: 联动 3 (0-禁止, 1 允许)</p> <p>Bit0: inverse time over current; Bit1: low definite-time over current; Bit2: high definite-time over current; Bit3: low definite-time zero sequence; Bit4: high definite-time zero sequence; Bit 5: inverse time zero sequence; Bit6: open phase; Bit7: unbalance; Bit8: current demand protection; Bit9: linkage 1; Bit10: linkage 2; Bit11: linkage 3 (0-prohibited; 1-allowed)</p>

113	扩展保护报警使能 Expansion protection alarm enabling	0-2047	R/W		Bit0: 欠压; Bit1: 过压; Bit2: 定时限漏电 (0-禁止, 1 允许) Bit0: undervoltage; Bit1: overvoltage; Bit2: definite-time leakage (0-prohibited, 1-allowed)
114	反时限过流保护动作值 Operate value of inverse time over current protection	10%-800 %	R/W		
115	反时限过流保护报警值 Alarm value of inverse time over current protection		R/W		
116	反时限零序保护动作值 Operate value of inverse time zero sequence protection	10%-800 %	R/W		
117	反时限零序保护报警值 Alarm value of inverse time zero sequence protection	10%-800 %	R/W		
118	低定时限过流保护延时 Delay of low definite-time over current protection	0.02-600	R/W		
119	低定时限过流保护阈值 Threshold value of low definite-time over current protection	10%-800 %	R/W		
120	低定时限过流报警阈值 Threshold value of low definite-time over current alarm	10%-800 %	R/W		
121	低定时限过流保护返回系数 Drop-off to pick-up ratio of low definite-time over current protection	5%-50%	R/W		
122	高定时限过流保护延时 Delay of high definite-time over current protection	0.02-600	R/W		
123	高定时限过流保护阈值 Threshold value of high definite-time over current protection	10%-800 %	R/W		
124	高定时限过流报警阈值 Threshold value of high definite-time over current alarm	10%-800 %	R/W		
125	高定时限过流保护返回系数 Drop-off to pick-up ratio of high definite-time over current protection	5%-50%	R/W		

126	低定时限零序保护延时 Delay of low definite-time zero sequence protection	0.02-600	R/W		
127	低定时限零序保护阈值 Threshold value of low definite-time zero sequence protection	10%-800 %	R/W		
128	低定时限零序报警阈值 Threshold value of low definite-time zero sequence alarm	10%-800 %	R/W		
129	低定时限零序保护返回系数 Drop-off to pick-up ratio of low definite-time zero sequence protection	5%-50%	R/W		
130	高定时限零序保护延时 Delay of high definite-time zero sequence protection	0.02-600	R/W		
131	高定时限零序保护阈值 Threshold value of high definite-time zero sequence protection	10%-800 %	R/W		
132	高定时限零序报警阈值 Threshold value of high definite-time zero sequence alarm	10%-800 %	R/W		
133	高定时限零序保护返回系数 Drop-off to pick-up ratio of high definite-time zero sequence protection	5%-50%	R/W		
134	断相保护延时 Delay of open phase protection	0.02-600	R/W		
135	不平衡保护延时 Delay of unbalance protection	0.02-600	R/W		
136	不平衡保护阈值 Threshold value of unbalance protection	10%-100 %	R/W		
137	不平衡报警阈值 Threshold value of unbalance alarm	10%-100 %	R/W		
138	不平衡返回系数 Drop-off to pick-up ratio of unbalance	5%-50%	R/W		
139	电流需量保护时间长度 Time length of current demand protection	1.0-20.0	R/W		

140	电流需量保护阈值 Threshold value of current demand protection	10%-800 %	R/W		
141	电流需量报警阈值 Threshold value of current demand alarm	10%-800 %	R/W		
142	电流需量保护返回系数 Drop-off to pick-up ratio of current demand protection	5%-50%	R/W		
143	联动 1 保护延时 Delay of linkage 1 protection	0.06-600	R/W		
144	联动 2 保护延时 Delay of linkage 2 protection	0.06-600	R/W		
145	联动 3 保护延时 Delay of linkage 3 protection	0.06-600	R/W		
146	欠压保护延时 Delay of undervoltage protection	0.02-600	R/W		
147	欠压保护阈值 Threshold value of undervoltage protection	45%-90%	R/W		
148	欠压报警阈值 Threshold value of undervoltage alarm	45%-90%	R/W		
149	欠压返回系数 Drop-off to pick-up ratio of undervoltage	5%-50%	R/W		
150	过压保护延时 Delay of overvoltage protection	0.02-600	R/W		
151	过压保护阈值 Threshold value of overvoltage protection	110%-150 %	R/W		
152	过压报警阈值 Threshold value of overvoltage alarm	110%-150 %	R/W		
153	过压返回系数 Drop-off to pick-up ratio of overvoltage	5%-50%	R/W		
154	定时限漏电延时 Delay of definite-time leakage	0.02-600	R/W		
155	定时限漏电保护阈值 Threshold value of definite-time leakage protection	30mA~1000mA	R/W		

156	定时限漏电报警阈值 Threshold value of definite-time leakage alarm	30mA~1000mA	R/W		
157	定时限漏电返回系数 Drop-off to pick-up ratio of definite-time leakage	5%-50%	R/W		
158	额定电压 Rated voltage	0-3300	R/W		
159	额定功率 Rated power	1-65535	R/W		
160	额定功率 Rated power	0-65535	R/W		
161	通讯协议 Communication protocol	1	R/W		1-MODBUS
162	通讯地址 Communication address	1-247	R/W		1-247 为 MODBUS 1-247 is MODBUS
163	波特率 Baud rate	1-4	R/W		0-2400; 1-4800; 2-9600; 3-19200; 4-38400
164	奇偶校验 Odd-even check	0-2	R/W		0- 无校验, 1-奇校验, 2-偶校验 1- 0-no parity; 1-odd parity check; 2-even parity check
165	停止位 Stop bit	0-1	R/W		0-1 个停止位, 1-2 个停止位 0-1 stop bit; 1-2 stop bits
166	背光 Backlight	0-1	R/W		0-自动, 3min 无动作关闭; 1-常量 0-Automatic; 3min-no action closed; 1-constant
167	模拟量输出类型 Analog output type	0-9	R/W		0-Ia; 1-Ib; 2-Ic; 3-Iav; 4-Imax; 5-Uab; 6-Ubc; 7-Uca; 8-P; 9-F
168	模拟量输出倍数 Analog output times	1-8	R/W		电流: 1-8; 电压: 1-2; 功率: 1-8; 频率: 65Hz Current: 1-8; voltage: 1-2; power: 1-8; frequency: 65Hz
169	DI1 状态 DI1 status	1-2	R/W		0- 常开; 1-常闭 1- 0-normally open; 1-normally closed

170	DI1 编程内容 DI1 programming content	0-10	R/W		0-普通 DI; 1-断路器状态; 2-本地分闸; 3-本地合闸; 4-远程分闸; 5-远程合闸; 6-本地、远程选择; 7-联动 1; 8 联动 2; 9-联动 3; 10-复位 0-common DI; 1-breaker status; 2-local opening; 3-local closing; 4-remote opening; 5-remote closing; 6-local, remote selection; 7-linkage 1; 8-linkage 2; 9-linkage 3; 10-reset
171	DI2 状态 DI1 status	1-2	R/W		0-常开, 1-常闭
172	DI2 编程内容 DI2 programming content	0-10	R/W		0-普通 DI; 1-断路器状态; 2-本地分闸; 3-本地合闸; 4-远程分闸; 5-远程合闸; 6-本地、远程选择; 7-联动 1; 8 联动 2; 9-联动 3; 10-复位 0-common DI; 1-breaker status; 2-local opening; 3-local closing; 4-remote opening; 5-remote closing; 6-local, remote selection; 7-linkage 1; 8-linkage 2; 9-linkage 3; 10-reset
173	DI3 状态 DI3 status	1-2	R/W		0-常开, 1-常闭
174	DI3 编程内容 DI3 programming content	0-10	R/W		0-普通 DI; 1-断路器状态; 2-本地分闸; 3-本地合闸; 4-远程分闸; 5-远程合闸; 6-本地、远程选择; 7-联动 1; 8 联动 2; 9-联动 3; 10-复位 0-common DI; 1-breaker status; 2-local opening; 3-local closing; 4-remote opening; 5-remote closing; 6-local, remote selection; 7-linkage 1; 8-linkage 2; 9-linkage 3; 10-reset
175	DI4 状态 DI4 status	1-2	R/W		0-常开, 1-常闭

176	DI4 编程内容 DI4 programming content	0-10	R/W	0-普通 DI; 1-断路器状态; 2-本地分闸; 3-本地合闸; 4-远程分闸; 5-远程合闸; 6-本地、远程选择; 7-联动 1; 8 联动 2; 9-联动 3; 10-复位 0-common DI; 1-breaker status; 2-local opening; 3-local closing; 4-remote opening; 5-remote closing; 6-local, remote selection; 7-linkage 1; 8-linkage 2; 9-linkage 3; 10-reset
177	DI5 状态 DI5 status	1-2	R/W	0-常开, 1-常闭
178	DI5 编程内容 DI5 programming content	0-10	R/W	0-普通 DI; 1-断路器状态; 2-本地分闸; 3-本地合闸; 4-远程分闸; 5-远程合闸; 6-本地、远程选择; 7-联动 1; 8 联动 2; 9-联动 3; 10-复位 0-common DI; 1-breaker status; 2-local opening; 3-local closing; 4-remote opening; 5-remote closing; 6-local, remote selection; 7-linkage 1; 8-linkage 2; 9-linkage 3; 10-reset
179	DI6 状态 DI6 status	1-2	R/W	0-常开, 1-常闭
180	DI6 编程内容 DI6 programming content	0-10	R/W	0-普通 DI; 1-断路器状态; 2-本地分闸; 3-本地合闸; 4-远程分闸; 5-远程合闸; 6-本地、远程选择; 7-联动 1; 8 联动 2; 9-联动 3; 10-复位 0-common DI; 1-breaker status; 2-local opening; 3-local closing; 4-remote opening; 5-remote closing; 6-local, remote selection; 7-linkage 1; 8-linkage 2; 9-linkage 3; 10-reset
181	DI7 状态 DI7 status	1-2	R/W	0-常开, 1-常闭 0-normally; 1-normally closed

182	DI7 编程内容 DI7 programming content	0-10	R/W	0- 普通 DI; 1-断路器状态; 2-本地分闸; 3-本地合闸; 4-远程分闸; 5-远程合闸; 6-本地、远程选择; 7-联动 1; 8 联动 2; 9-联动 3; 10-复位 0-common DI; 1-breaker status; 2-local opening; 3-local closing; 4-remote opening; 5-remote closing; 6-local, remote selection; 7-linkage 1; 8-linkage 2; 9-linkage 3; 10-reset
183	DI8 状态 DI8 status	1-2	R/W	0-常开, 1-常闭
184	DI8 编程内容 DI8 programming content	0-10	R/W	0- 普通 DI; 1-断路器状态; 2-本地分闸; 3-本地合闸; 4-远程分闸; 5-远程合闸; 6-本地、远程选择; 7-联动 1; 8 联动 2; 9-联动 3; 10-复位 0-common DI; 1-breaker status; 2-local opening; 3-local closing; 4-remote opening; 5-remote closing; 6-local, remote selection; 7-linkage 1; 8-linkage 2; 9-linkage 3; 10-reset
185	DI9 状态 DI9 status	1-2	R/W	0- 常开, 1-常闭 0-normally open; 1-normally closed
186	DI9 编程内容 DI9 programming content	0-10	R/W	0- 普通 DI; 1-断路器状态; 2-本地分闸; 3-本地合闸; 4-远程分闸; 5-远程合闸; 6-本地、远程选择; 7-联动 1; 8 联动 2; 9-联动 3; 10-复位 0-common DI; 1-breaker status; 2-local opening; 3-local closing; 4-remote opening; 5-remote closing; 6-local, remote selection; 7-linkage 1; 8-linkage 2; 9-linkage 3; 10-reset
187	DO1 模式 DO1 mode	1-2	R/W	1- 电平; 2 脉冲 1-level; 2-pulse

188	DO1 输出 DO1 output	0-11	R/W	0-普通 DO; 1-分闸输出; 2-合闸输出; 3-总故障输出; 4-总报警输出; 5-真值表 1 输出; 6-真值表 2 输出; 7-真值表 3 输出; 8-自诊断输出 0-common DO; 1-opening output; 2-closing output; 3- total fault output; 4-total alarm output; 5-truth table 1 output; 6-truth table 2 output; 7-truth table 3 output; 8-self-diagnostic output
189	DO1 脉冲宽度 DO1 pulse width	1-5	R/W	步长 1s Step length: 1s
190	DO2 模式 DO2 mode	1-2	R/W	1- 电平; 2 脉冲 1-level; 2-pulse
191	DO2 输出 DO2 output	0-11	R/W	0-普通 DO; 1-分闸输出; 2-合闸输出; 3-总故障输出; 4-总报警输出; 5-真值表 1 输出; 6-真值表 2 输出; 7-真值表 3 输出; 8-自诊断输出 0-common DO; 1-opening output; 2-closing output; 3- total fault output; 4-total alarm output; 5-truth table 1 output; 6-truth table 2 output; 7-truth table 3 output; 8-self-diagnostic output
192	DO2 脉冲宽度 DO2 pulse width	1-5	R/W	步长 1s Step length: 1s
193	DO3 模式 DO3 mode	1-2	R/W	1- 电平; 2 脉冲 1-level; 2-pulse
194	DO3 输出 DO3 output	0-11	R/W	0-普通 DO; 1-分闸输出; 2-合闸输出; 3-总故障输出; 4-总报警输出; 5-真值表 1 输出; 6-真值表 2 输出; 7-真值表 3 输出; 8-自诊断输出 0-common DO; 1-opening output; 2-closing output; 3- total fault output; 4-total alarm output; 5-truth table 1 output; 6-truth table 2 output; 7-truth table 3 output; 8-self-diagnostic output
195	DO3 脉冲宽度 DO3 pulse width	1-5	R/W	步长 1s Step length: 1s
196	DO4 模式 DO4 mode	1-2	R/W	1- 电平; 2 脉冲 1-level; 2-pulse

197	DO4 输出 DO4 output	0-11	R/W	0-普通 DO; 1-分闸输出; 2-合闸输出; 3-总故障输出; 4-总报警输出; 5-真值表 1 输出; 6-真值表 2 输出; 7-真值表 3 输出; 8-自诊断输出 0-common DO; 1-opening output; 2-closing output; 3- total fault output; 4-total alarm output; 5-truth table 1 output; 6-truth table 2 output; 7-truth table 3 output; 8-self-diagnostic output
198	DO4 脉冲宽度 DO4 pulse width	1-5	R/W	步长 1s Step length: 1s
199	DO5 模式 DO5 mode	1-2	R/W	1- 电平; 2 脉冲 1-level; 2-pulse
200	DO5 输出 DO5 output	0-11	R/W	0-普通 DO; 1-分闸输出; 2-合闸输出; 3-总故障输出; 4-总报警输出; 5-真值表 1 输出; 6-真值表 2 输出; 7-真值表 3 输出; 8-自诊断输出 0-common DO; 1-opening output; 2-closing output; 3- total fault output; 4-total alarm output; 5-truth table 1 output; 6-truth table 2 output; 7-truth table 3 output; 8-self-diagnostic output
201	DO5 脉冲宽度 DO5 pulse width	1-5	R/W	步长 1s Step length: 1s
202	可编程输出 1 编程类型 Programming type of programmable output 1	0-7	R/W	0-关闭; 1-A; 2-A*B; 3-A+B; 4-A*B*C; 5-(A+B)*C; 6-A*B+C; 7-A+B+C 0-closed; 1-A; 2-A*B; 3-A+B; 4-A*B*C; 5-(A+B)*C; 6-A*B+C; 7-A+B+C

203	可编程 1 输入条件 A Input condition A of programmable 1	0-23	R/W	0-无输入；1-反时限过流；2-低定时限过流；3-高定时限过流；4-低定时限零序；5-高定时限零序；6-反时限零序；7-断相；8-不平衡；9-电流需量；10-联动 1；11-联动 2；12-联动 3；13-欠压；14-过压；15-定时限漏电； 16-DI1;17-DI2;18-DI3;19-DI4;20-DI5;21-DI6;22-DI7;23-DI8;24-DI9 0-no input; 1- inverse time over current; 2-low definite-time over current; 3-high definite-time over current; 4-low definite-time zero sequence; 5- high definite-time zero sequence; 6-inverse zero sequence; 7-open phase; 8-unbalance; 9-current demand; 10-linkage 1; 11-linkage 2; 12-linkage 3; 13-undervoltage; 14-overvoltage; 15-definite-time leakage; 16-DI1;17-DI2;18-DI3;19-DI4;20-DI5;21-DI6;22-DI7;23-DI8;24-DI9
-----	---	------	-----	--

204	可编程 1 输入条件 B Input condition B of programmable 1	0-23	R/W	0-无输入; 1-反时限过流; 2-低定时限过流; 3-高定时限过流; 4-低定时限零序; 5-高定时限零序; 6-反时限零序; 7-断相; 8-不平衡; 9-电流需量; 10-联动 1; 11-联动 2; 12-联动 3; 13-欠压; 14-过压; 15-定时限漏电; 16-DI1;17-DI2;18-DI3;19-DI4;20-DI5;21-DI6;22-DI7;23-DI8;24-DI9 0-no input; 1- inverse time over current; 2-low definite-time over current; 3-high definite-time over current; 4-low definite-time zero sequence; 5- high definite-time zero sequence; 6-inverse zero sequence; 7-open phase; 8-unbalance; 9-current demand; 10-linkage 1; 11-linkage 2; 12-linkage 3; 13-undervoltage; 14-overvoltage; 15-definite-time leakage; 16-DI1;17-DI2;18-DI3;19-DI4;20-DI5;21-DI6;22-DI7;23-DI8;24-DI9
-----	--	------	-----	---

205	可编程 1 输入条件 C Input condition C of programmable 1	0-23	R/W	0-无输入; 1-反时限过流; 2-低定时限过流; 3-高定时限过流; 4-低定时限零序; 5-高定时限零序; 6-反时限零序; 7-断相; 8-不平衡; 9-电流需量; 10-联动 1; 11-联动 2; 12-联动 3; 13-欠压; 14-过压; 15-定时限漏电; 16-DI1;17-DI2;18-DI3;19-DI4;20-DI5;21-DI6;22-DI7;23-DI8;24-DI9 0-no input; 1- inverse time over current; 2-low definite-time over current; 3-high definite-time over current; 4-low definite-time zero sequence; 5- high definite-time zero sequence; 6-inverse zero sequence; 7-open phase; 8-unbalance; 9-current demand; 10-linkage 1; 11-linkage 2; 12-linkage 3; 13-undervoltage; 14-overvoltage; 15-definite-time leakage; 16-DI1;17-DI2;18-DI3;19-DI4;20-DI5;21-DI6;22-DI7;23-DI8;24-DI9
206	可编程输出 2 编程类型 Programming type of programmable output 2	0-7	R/W	0-关闭 closed;1-A;2-A*B;3-A+B;4-A*B*C;5-(A+B)*C;6-A*B+C;7-A+B+C

207	可编程 2 输入条件 A Input condition A of programmable 2	0-23	R/W	0-无输入；1-反时限过流；2-低定时限过流；3-高定时限过流；4-低定时限零序；5-高定时限零序；6-反时限零序；7-断相；8-不平衡；9-电流需量；10-联动 1；11-联动 2；12-联动 3；13-欠压；14-过压；15-定时限漏电； 16-DI1;17-DI2;18-DI3;19-DI4;20-DI5;21-DI6;22-DI7;23-DI8;24-DI9 0-no input; 1- inverse time over current; 2-low definite-time over current; 3-high definite-time over current; 4-low definite-time zero sequence; 5- high definite-time zero sequence; 6-inverse zero sequence; 7-open phase; 8-unbalance; 9-current demand; 10-linkage 1; 11-linkage 2; 12-linkage 3; 13-undervoltage; 14-overvoltage; 15-definite-time leakage; 16-DI1;17-DI2;18-DI3;19-DI4;20-DI5;21-DI6;22-DI7;23-DI8;24-DI9
-----	---	------	-----	--

208	可编程 2 输入条件 B Input condition B of programmable 2	0-23	R/W	0-无输入； 1-反时限过流； 2-低定时限过流； 3-高定时限过流； 4-低定时限零序； 5-高定时限零序； 6-反时限零序； 7-断相； 8-不平衡； 9-电流需量； 10-联动 1； 11-联动 2； 12-联动 3； 13-欠压； 14-过压； 15-定时限漏电； 16-DI1;17-DI2;18-DI3;19-DI4;20-DI5;21-DI6;22-DI7;23-DI8;24-DI9 0-no input; 1- inverse time over current; 2-low definite-time over current; 3-high definite-time over current; 4-low definite-time zero sequence; 5- high definite-time zero sequence; 6-inverse zero sequence; 7-open phase; 8-unbalance; 9-current demand; 10-linkage 1; 11-linkage 2; 12-linkage 3; 13-undervoltage; 14-overvoltage; 15-definite-time leakage; 16-DI1;17-DI2;18-DI3;19-DI4;20-DI5;21-DI6;22-DI7;23-DI8;24-DI9
-----	---	------	-----	---

209	可编程 2 输入条件 C Input condition C of programmable 2	0-23	R/W	0-无输入; 1-反时限过流; 2-低定时限过流; 3-高定时限过流; 4-低定时限零序; 5-高定时限零序; 6-反时限零序; 7-断相; 8-不平衡; 9-电流需量; 10-联动 1; 11-联动 2; 12-联动 3; 13-欠压; 14-过压; 15-定时限漏电; 16-DI1;17-DI2;18-DI3;19-DI4;20-DI5;21-DI6;22-DI7;23-DI8;24-DI9 0-no input; 1- inverse time over current; 2-low definite-time over current; 3-high definite-time over current; 4-low definite-time zero sequence; 5- high definite-time zero sequence; 6-inverse zero sequence; 7-open phase; 8-unbalance; 9-current demand; 10-linkage 1; 11-linkage 2; 12-linkage 3; 13-undervoltage; 14-overvoltage; 15-definite-time leakage; 16-DI1;17-DI2;18-DI3;19-DI4;20-DI5;21-DI6;22-DI7;23-DI8;24-DI9
210	可编程输出 3 编程类型 Programming type of programmable output 3	0-7	R/W	0-关闭 closed;1-A;2-A*B;3-A+B;4-A*B*C;5-(A+B)*C;6-A*B+C;7-A+B+C

211	可编程 3 输入条件 A Input condition A of programmable 3	0-23	R/W	0-无输入； 1-反时限过流； 2-低定时限过流； 3-高定时限过流； 4-低定时限零序； 5-高定时限零序； 6-反时限零序； 7-断相； 8-不平衡； 9-电流需量； 10-联动 1； 11-联动 2； 12-联动 3； 13-欠压； 14-过压； 15-定时限漏电； 16-DI1;17-DI2;18-DI3;19-DI4;20-DI5;21-DI6;22-DI7;23-DI8;24-DI9 0-no input; 1- inverse time over current; 2-low definite-time over current; 3-high definite-time over current; 4-low definite-time zero sequence; 5- high definite-time zero sequence; 6-inverse zero sequence; 7-open phase; 8-unbalance; 9-current demand; 10-linkage 1; 11-linkage 2; 12-linkage 3; 13-undervoltage; 14-overvoltage; 15-definite-time leakage; 16-DI1;17-DI2;18-DI3;19-DI4;20-DI5;21-DI6;22-DI7;23-DI8;24-DI9
-----	---	------	-----	---

212	可编程 3 输入条件 B Input condition B of programmable 3	0-23	R/W	0-无输入; 1-反时限过流; 2-低定时限过流; 3-高定时限过流; 4-低定时限零序; 5-高定时限零序; 6-反时限零序; 7-断相; 8-不平衡; 9-电流需量; 10-联动 1; 11-联动 2; 12-联动 3; 13-欠压; 14-过压; 15-定时限漏电; 16-DI1;17-DI2;18-DI3;19-DI4;20-DI5;21-DI6;22-DI7;23-DI8;24-DI9 0-no input; 1- inverse time over current; 2-low definite-time over current; 3-high definite-time over current; 4-low definite-time zero sequence; 5- high definite-time zero sequence; 6-inverse zero sequence; 7-open phase; 8-unbalance; 9-current demand; 10-linkage 1; 11-linkage 2; 12-linkage 3; 13-undervoltage; 14-overvoltage; 15-definite-time leakage; 16-DI1;17-DI2;18-DI3;19-DI4;20-DI5;21-DI6;22-DI7;23-DI8;24-DI9
-----	--	------	-----	---

213	可编程 3 输入条件 C Input condition C of programmable 3	0-23	R/W		0-无输入; 1-反时限过流; 2-低定时限过流; 3-高定时限过流; 4-低定时限零序; 5-高定时限零序; 6-反时限零序; 7-断相; 8-不平衡; 9-电流需量; 10-联动 1; 11-联动 2; 12-联动 3; 13-欠压; 14-过压; 15-定时限漏电; 16-DI1;17-DI2;18-DI3;19-DI4;20-DI5;21-DI6;22-DI7;23-DI8;24-DI9 0-no input; 1- inverse time over current; 2-low definite-time over current; 3-high definite-time over current; 4-low definite-time zero sequence; 5- high definite-time zero sequence; 6-inverse zero sequence; 7-open phase; 8-unbalance; 9-current demand; 10-linkage 1; 11-linkage 2; 12-linkage 3; 13-undervoltage; 14-overvoltage; 15-definite-time leakage; 16-DI1;17-DI2;18-DI3;19-DI4;20-DI5;21-DI6;22-DI7;23-DI8;24-DI9
214-223	预留 Reserved				
224	反时限过流保护时间系数 Inverse time over current time protection coefficient	0.025-1.5s	R/W		
225	反时限过流复位时间系数 Inverse time over current reset time coefficient	0.025-3.2s	R/W		
226	反时限零序保护时间系数 Inverse time zero sequence protection time coefficient	0.025-1.5s	R/W		
227-399	预留 Reserved				
400-640	故障记录通讯记录, 见表 17 See Table 20 for the failure record communication log.				
641-659	预留 Reserved				
660-740	合闸记录通讯记录, 见表 18 See Table 21 for the closing record communication log.				
741-749	预留 Reserved				

750-830	分闸记录通讯记录, 见表 19 See Table 22 for opening record communication log.
831-849	预留 Reserved
850-900	DDI 动作记录通讯记录, 见表 20 See Table 23 for DDI operate record communication log.
900-967	预留 Reserved

ALP 系列故障记录通讯地址见表 17 所示。

See Table 17 for ALP series failure record communication address.

表 17 ALP 系列故障记录通讯地址表

Table 17 ALP series failure record communication address table

地址 Address	名称 Name	属性 Attribute	数据格式 Data format	备注 Remarks
400	故障记录:最新故障记录通讯地址 Failure record-latest failure record communication address	R	Word	401、431、461、491、521、551、581、611
401	故障记录:故障年月 Failure record: failure year/month	R	Word	
402	故障记录:故障日时 Failure record: failure day/hour	R	Word	
403	故障记录:故障分秒 Failure record: failure minute/second	R	Word	
404	故障记录:基本故障脱扣位 Failure record: basic failure tripping bit	R	Word	Bit0: 反时限过流; Bit1: 低定 时限过流; Bit2: 高定时限过流; Bit3: 低定时限零序; Bit4: 高 定时限零序; Bit5: 反时限零序; Bit6: 断 相; Bit7: 不平衡; Bit8: 电流需量 保护; Bit9: 联动 1; Bit10: 联动 2; Bit11: 联动 3 (0-禁止, 1 允许) Bit0: inverse time over current; Bit1: low definite-time over current; Bit2: high definite-time over current; Bit3: low definite-time zero sequence; Bit4: high definite-time zero sequence; Bit5: inverse time zero sequence; Bit6: open phase; Bit7: unbalance; Bit8: current demand protection; Bit9: linkage 1; Bit10: linkage 2; Bit11: linkage 3 (0: prohibited, 1: allowed)

405	故障记录:扩展故障脱扣位 Failure record: expansion failure tripping bit	R	Word	Bit0: 欠压; Bit1: 过压; Bit2: 定时限漏电 (0-禁止, 1 允许) Bit0: undervoltage; Bit1: overvoltage; Bit2: definite-time leakage (0-prohibited; 1-allowed)
406	故障记录:基本报警脱扣位 Failure record: basic alarm tripping bit	R	Word	Bit0: 反时限过流; Bit1: 低定时限过流; Bit2: 高定时限过流; Bit3: 低定时限零序; Bit4: 高定时限零序; Bit5: 反时限零序; Bit6: 断相; Bit7: 不平衡; Bit8: 电流需量保护; Bit9: 联动 1; Bit10: 联动 2; Bit11: 联动 3 (0-禁止, 1 允许) Bit0: inverse time over current; Bit1: low definite-time over current; Bit2: high definite-time over current; Bit3: low definite-time zero sequence; Bit4: high definite-time zero sequence; Bit5: inverse time zero sequence; Bit6: open phase; Bit7: unbalance; Bit8: current demand protection; Bit9: linkage 1; Bit10: linkage 2; Bit11: linkage 3 (0: prohibited, 1: allowed)
407	故障记录:扩展报警脱扣位 Failure record: expansion alarm tripping bit	R	Word	Bit0: 欠压; Bit1: 过压; Bit2: 定时限漏电 (0-禁止, 1 允许) Bit0: undervoltage; Bit1: overvoltage; Bit2: definite-time leakage (0-prohibited; 1-allowed)
408	故障记录:A 相电流 Failure record: A-phase current	R	Word	
409	故障记录:B 相电流 Failure record: B-phase current	R	Word	
410	故障记录:C 相电流 Failure record: C-phase current	R	Word	
411	故障记录:电流不平衡度 Failure record: current unbalance degree	R	Word	
412	故障记录:接地电流 Failure record: grounding current	R	Word	
413	故障记录:漏电流 Failure record: leakage current	R	Word	
414	故障记录:AB 相电压 Failure record: AB-phase voltage	R	Word	
415	故障记录:BC 相电压 Failure record: BC-phase voltage	R	Word	

416	故障记录:CA 相电压 Failure record: CA-phase voltage	R	Word	
417	故障记录:频率 Failure record: frequency	R	Word	
418				
419				
420-430	预留 Reserved			

注意：剩余故障记录地址起始地址分别为 431、461、491、521、551、581、611，数据格式与表 17 相同。

Note: The initial addresses of residual failure record address are respectively 431, 461, 491, 521, 551, 581 and 611. The data format is the same as Table 17.

ALP 系列合闸记录通讯地址见表 18 所示。

See Table 18 for ALP series closing record communication address.

表 18 ALP 系列合闸记录通讯地址表

Table 18 ALP series closing record communication address table

地址 Address	名称 Name	属性 Attribute	数据格式 Data format	备注 Remarks
660	合闸记录：最新通讯地址 Closing record: latest communication address	R	Word	661, 671, 681, 691, 701, 711, 721, 731
661	合闸记录：合闸年月 Closing record: closing year/month	R	Word	
662	合闸记录：合闸日时 Closing record: closing day/hour	R	Word	
663	合闸记录：合闸分秒 Closing record: closing minute/second	R	Word	
664	合闸记录：合闸原因 Closing record: closing cause	R	Word	Bit0:外部分闸，断路器状态采集，1=闭合，0=断开；Bit1：通讯合闸；Bit2：本地合闸；Bit3：远方合闸；Bit1-Bit3 为 1，并且 Bit0 为 1 表示断路器合闸正确，并且状态正确，显示 Bit1-Bit3 为合闸原因。Bit1-Bit3 为 0，Bit1 为 1 表示外部合闸成功 Bit0: external opening, breaker status collection; 1=closed, 0=disconnected; Bit1: communication closing; Bit2: local closing; Bit3: remote closing; Bit1-Bit3 is 1; when Bit0 is 1, it means that the breaker closing is correct and the status is correct and means that Bit1-Bit3 is closing cause. Bit1-Bit3 is 0; when Bit 1 is 1, it means that external closing is successful.
665-670	预留 Reserved			

注意：剩余合闸记录地址起始地址分别为 671、681、691、701、711、721、731，数据格式与表

18 相同。

Note: The initial addresses of residual closing record address are 671, 681, 691, 701, 711, 721 and 731. The data format is the same as Table 18.

ALP 系列分闸记录通讯地址见表 19 所示。

See Table 19 for ALP series opening record communication address.

表 19 ALP 系列分闸记录通讯地址表

Table 19 ALP series opening record communication address table

地址 Address	名称 Name	属性 Attribute	数据格式 Data format	备注 Remarks
750	分闸记录：最新通讯地址 Opening record: latest communication address	R	Word	751、761、771、781、791、801、811、821
751	分闸记录：分闸年月 Opening record: opening year/month	R	Word	
752	分闸记录：分闸日时 Opening record: opening day/hour	R	Word	
753	分闸记录：分闸分秒 Opening record: opening minute/second	R	Word	
754	分闸记录：分闸原因 Opening record: opening cause	R	Word	Bit4:故障分闸；Bit3:远方分闸；Bit2:本地分闸；Bit1:通讯分闸；Bit0:外部分闸 Bit4: fault opening; Bit3: remote opening; Bit2: local opening; Bit1:communication opening; Bit0: external opening
755-760	预留			

注意：剩余分闸记录地址起始地址分别为 761、771、781、791、801、811、821，数据格式与表 19 相同。

Note: The initial addresses for residual opening record are respectively 761, 771, 781, 791, 801, 811 and 821 and the data format is the same as Table 19.

ALP 系列 DI 动作记录通讯地址见表 20 所示。

See Table 20 for the ALP series DI operate record communication address.

表 20 ALP 系列 DI 动作记录通讯地址表

Table 20 ALP series DI operate record communication address table

地址 Address	名称 Name	属性 Attribute	数据格式 Data format	备注 Remarks
850	DI 动作记录：最新通讯地址 DI operate record: latest communication address	R	Word	851, 857, 863, 869, 875, 881, 887, 893
851	DI 动作记录：分闸年月 DI operate record: opening year/month	R	Word	

852	DI 动作记录: 分闸日时 DI operate record: opening day/hour	R	Word	
853	DI 动作记录: 分闸分秒 DI operate record: opening minute/second	R	Word	
854	DI 动作记录: DI 状态 DI operate record: DI status	R	Word	高 8 位判断 DIX: 1-5 对应 DI1-DI5; 低 8 位判断原因 1=断开, 2=闭合 High 8-digit judgment DIX: 1-5 corresponds DI1-DI5; low 8-digit judgment cause: 1=disconnected; 2=closed.
855-856	预留 Reserved			

注意: 剩余 DI 动作记录地址起始地址分别为 857、863、869、875、881、887、893, 数据格式与表 20 相同。

Note: The initial addressed for residual DI action record address are 857, 863, 869, 875, 881, 887 and 893 and the data format is the same as Table 20.

9.典型应用原理图 Typical application schematic diagram

9.1 ALP200 装置接线图 ALP200 device wiring diagram

9.1.2 ALP200 装置接线图 1 (适用于 25,100,160,400A 电流规格)

ALP200 device wiring diagram 1 (Suitable for 25,100,160,400A current specifications)

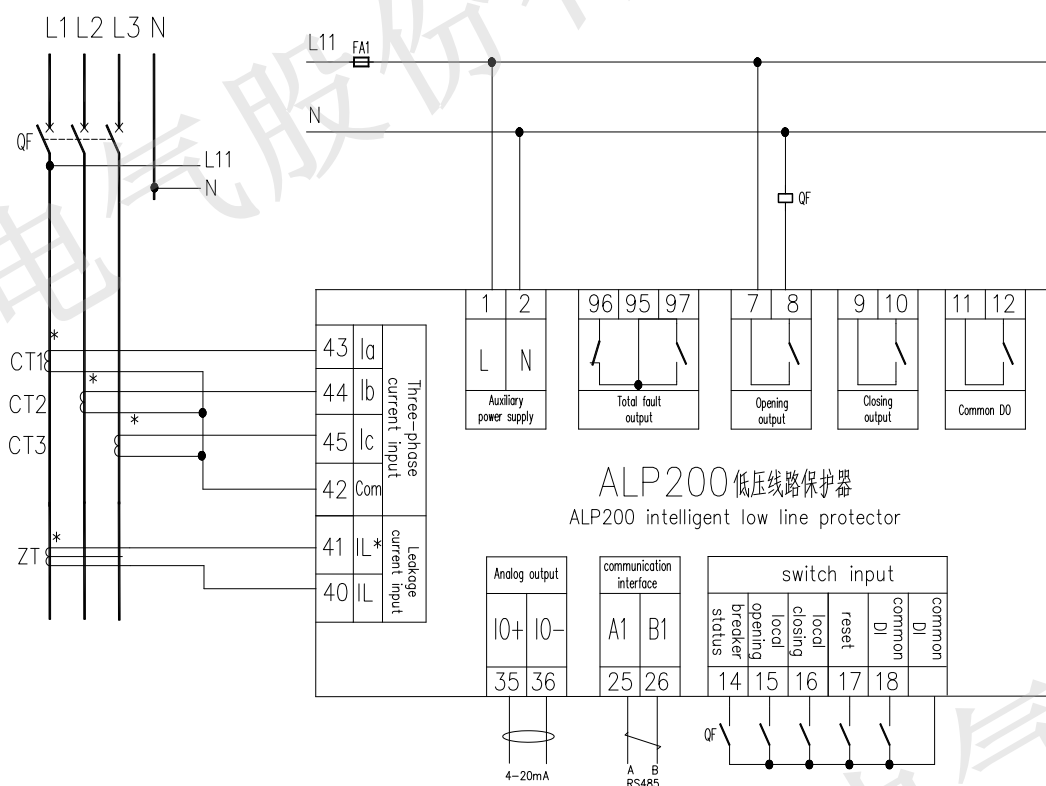

9.1.2 ALP200 装置接线图 2 (适用于 1、5A 电流规格)

ALP200 device wiring diagram 2 (Suitable for 1A,5A current specifications)

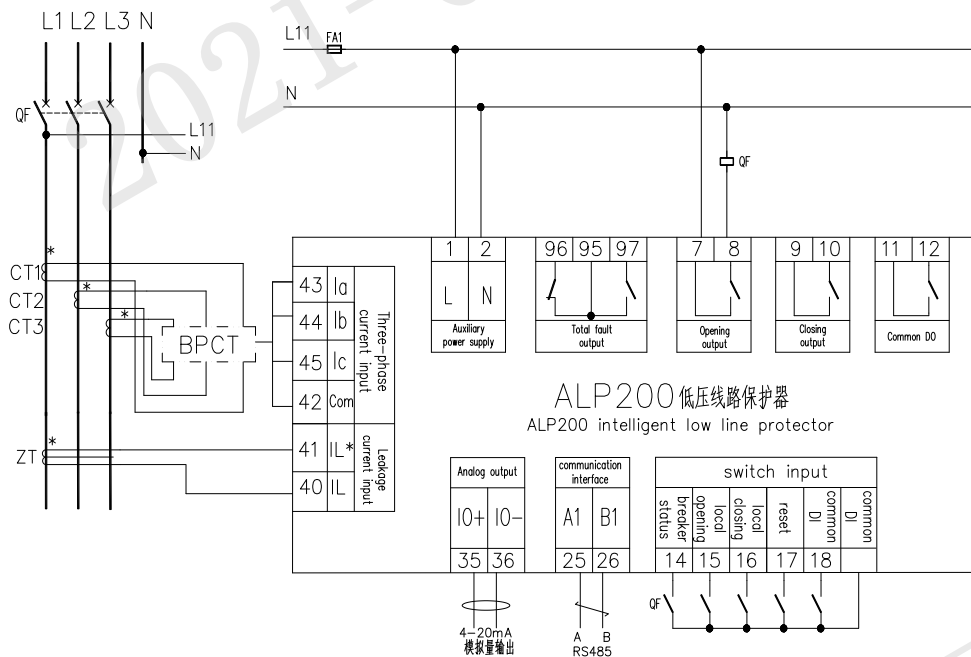

注：选用 1A、5A 规格的 ALP200 低压线路保护器时，需要先通过 /1、/5 的互感器将一次侧电流转换成 1A、5A 的电流，然后再通过标配的 100A/20mA 电流互感器输入到 ALP200 使用。图中 TA1、TA2、TA3 为 /1、/5 互感器，需要客户自行购买，BPCT 为我司标配的 100A/20mA 电流互感器。

Note: When selecting ALP200 low-voltage line protectors with 1A and 5A specifications, you need to convert the primary current to 1A and 5A through the / 1, / 5 transformer, and then pass the standard 100A / 20mA current transformer Input to ALP200 for use. TA1, TA2, TA3 are / 1, / 5 transformers, which need to be purchased by customers. BPCT is a 100A / 20mA current transformer standard for our company.

9.2 ALP220 装置接线图 ALP220 device wiring diagram

9.2.1 ALP220 装置接线图 1（适用于 25、100、160、400A 电流规格）

ALP220 device wiring diagram 1 (Suitable for 25,100,160,400A current specifications)

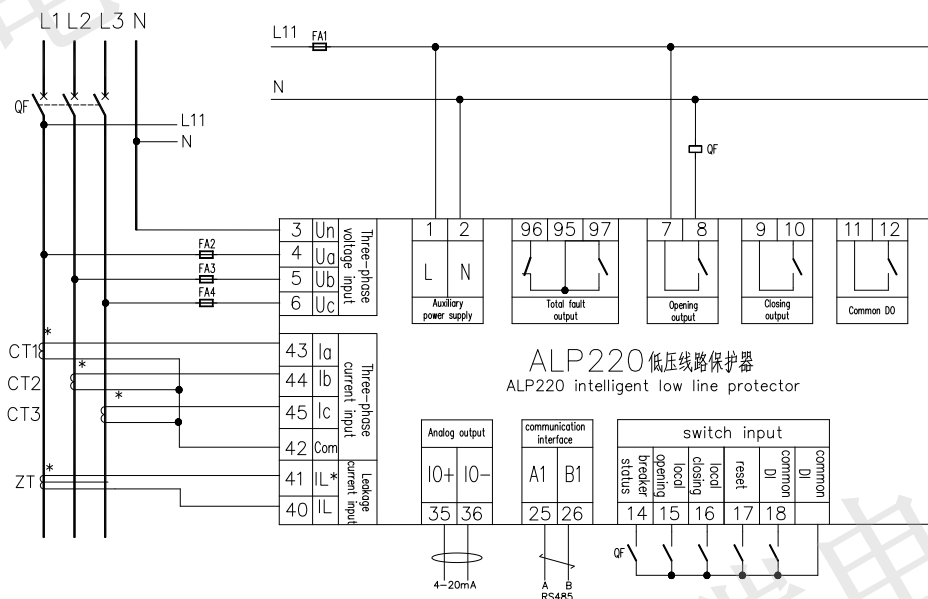

9.2.2 ALP220 装置接线图 2（适用于 1、5A 电流规格）

ALP220 device wiring diagram 2 (Suitable for 1,5A current specifications)

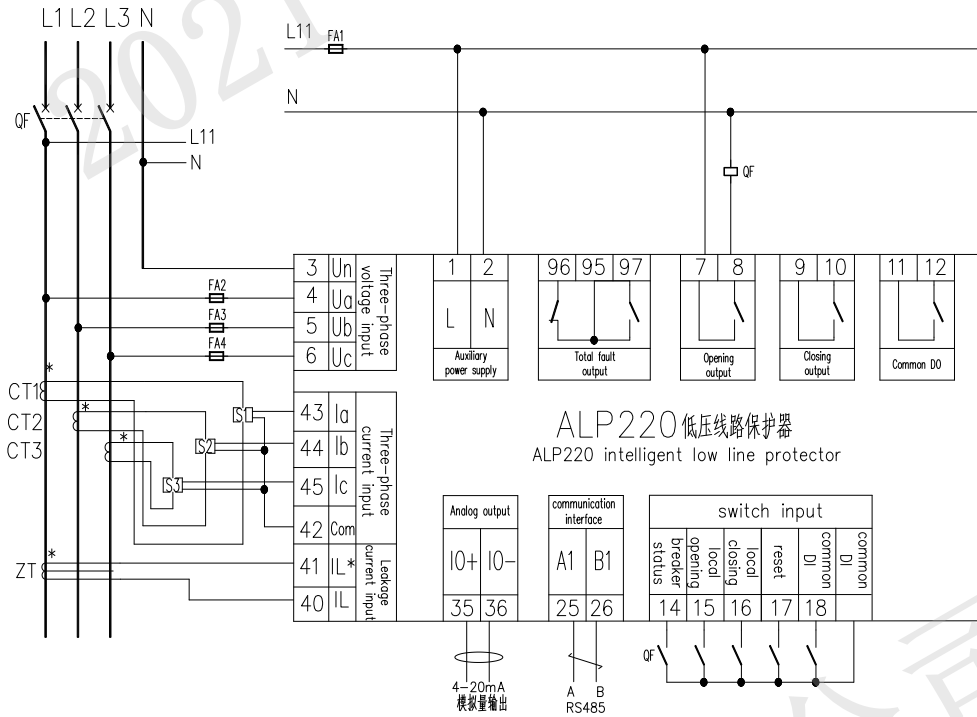

注：选用 1A、5A 规格的 ALP220 低压线路保护器时，需要先通过/1、/5 的互感器将一次侧电流转换成 1A、5A 的电流，然后再通过标配的 20A/20mA 电流互感器输入到 ALP220 使用。图中 TA1、TA2、TA3 为/1、/5 互感器，需要客户自行购买，S1、S2、S3 为我司标配的 20A/20mA 电流互感器(5A 规格穿芯 2 匝，1A 规格穿芯 8 匝)。

Note: When selecting ALP220 low-voltage line protectors with 1A and 5A specifications, you need to convert the primary current to 1A and 5A through the / 1 and / 5 transformers, and then pass the standard 20A / 20mA current transformer Input to ALP220 for use. In the picture, TA1, TA2, and TA3 are / 1 and / 5 transformers, which need to be purchased by customers. S1, S2, and S3 are 20A / 20mA current transformers (5A size winding 2 turns, 1A size winding 8 turns)

9.2.3 ALP220 装置接线图 3 (适用于三相三线系统)

ALP220 device wiring diagram 3 (Suitable for three-phase three-wire system)

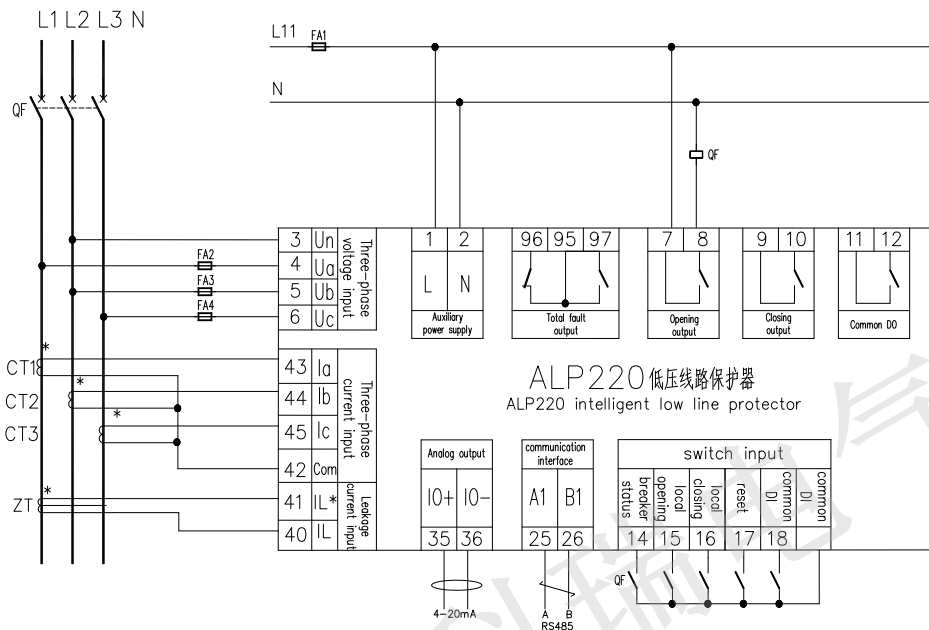

9.3 ALP320 装置接线图 ALP320 device wiring diagram

9.3.1 ALP320 装置接线图 1（适用于 25、100、160、400A 电流规格）

ALP320 device wiring diagram 1 (Suitable for 25,100,160,400A current specifications)

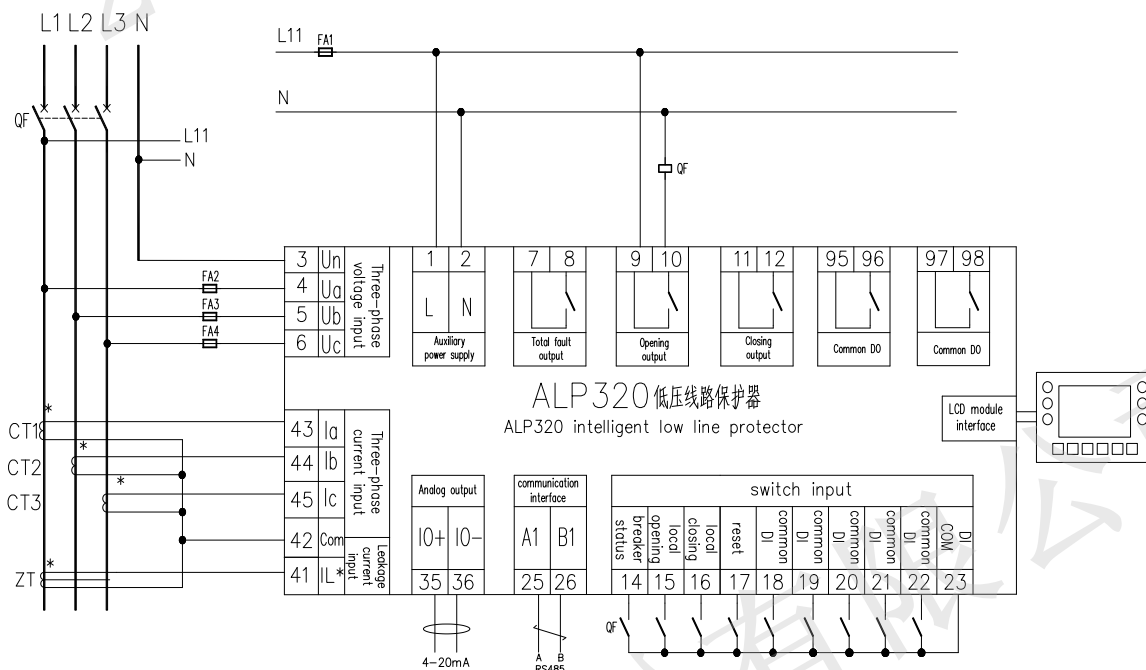

9.3.2 ALP320 装置接线图 2（适用于 1、5A 电流规格）

ALP320 device wiring diagram 2 (Suitable for 1,5A current specifications)

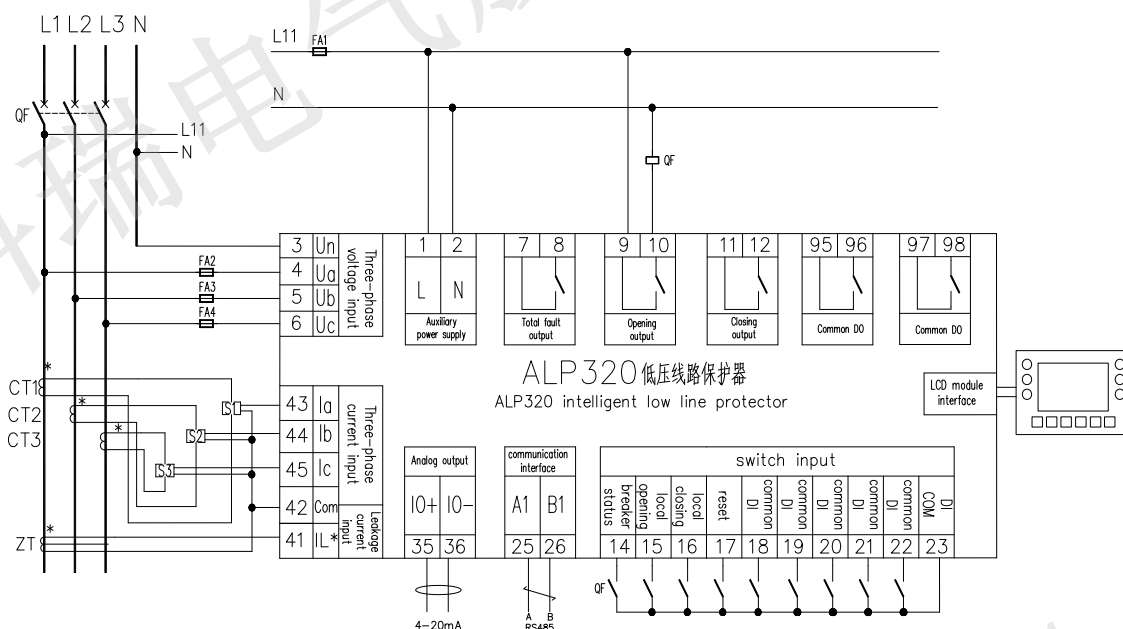

注：选用 1A、5A 规格的 ALP320 低压线路保护器时，需要先通过 /1、/5 的互感器将一次侧电流转换成 1A、5A 的电流，然后再通过标配的 20A/20mA 电流互感器输入到 ALP320 使用。图中 TA1、TA2、TA3 为 /1、/5 互感器，需要客户自行购买，S1、S2、S3 为我司标配的 20A/20mA 电流互感器(5A 规格穿芯 2 匝，1A 规格穿芯 8 匝)。

Note: When selecting ALP320 low-voltage line protectors with 1A and 5A specifications, you need to convert the primary current to 1A and 5A through the / 1 and / 5 transformers, and then pass the standard 20A / 20mA current transformer Input to ALP220 for use. In the picture, TA1, TA2, and TA3 are / 1 and / 5

transformers, which need to be purchased by customers. S1, S2, and S3 are 20A / 20mA current transformers (5A size winding 2 turns, 1A size winding) 8 turns)

9.3.3 ALP320 装置接线图 3 (适用于三相三线系统)

ALP320 device wiring diagram 3 (Suitable for three-phase three-wire system)

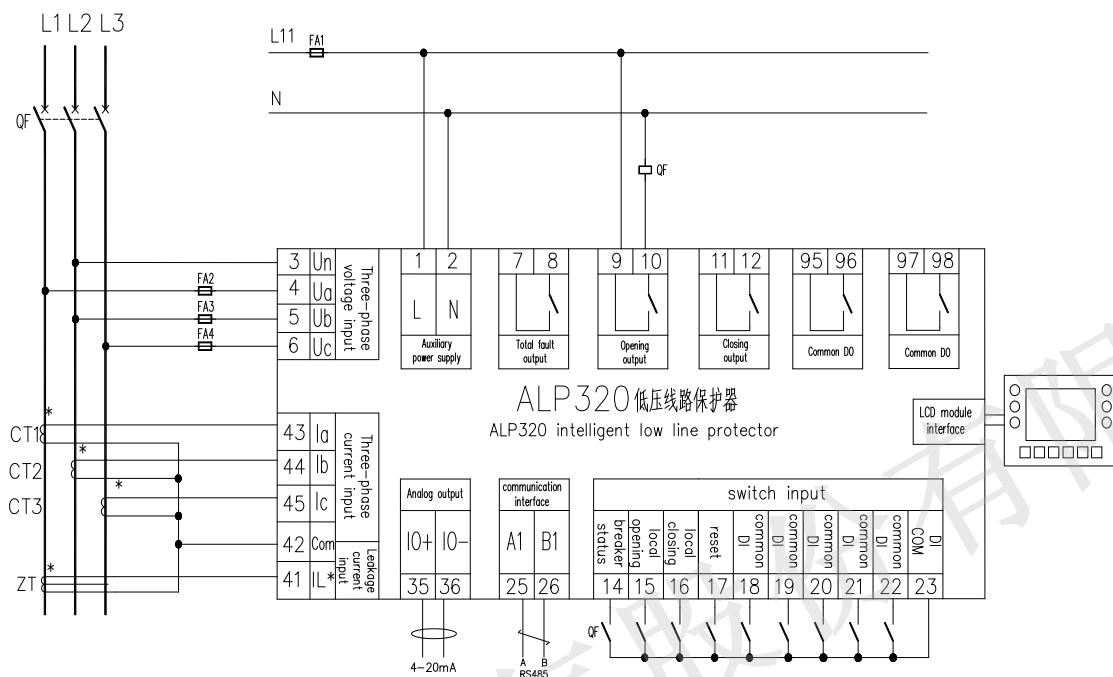

总部：安科瑞电气股份有限公司
Headquarter: Acrel Co., LTD.
地址：上海市嘉定区育绿路 253 号

Address: No.253 Yulv Road Jiading District, Shanghai , China

电话：0086-21-69158338 0086-21-69156052 0086-21-59156392 0086-21-69156971
TEL.: 0086-21-69158338 0086-21-69156052 0086-21-59156392 0086-21-69156971
传真：0086-21-69158303

Fax: 0086-21-69158303

网址：www.acrel-electric.com

Web-site: www.acrel-electric.com

邮箱：ACREL008@vip.163.com

Email : ACREL008@vip.163.com

邮编：201801

Postcode: 201801

生产基地：江苏安科瑞电器制造有限公司

Manufacturer: Jiangsu Acrel Electrical Manufacturing Co., LTD.

地址：江苏省江阴市南闸街道东盟工业园区东盟路 5 号

Address : No.5 Dongmeng Road,Dongmeng industrial Park, Nanzha Street,Jiangyin
City,Jiangsu Province,China

电话(传真)：0086-510-86179970

TEL./Fax: 0086-510-86179970

网址：www.jsacrel.com

Web-site: www.jsacrel.com

邮箱：JY-ACREL001@vip.163.com

Email:JY-ACREL001@vip.163.com

邮编：214405

Postcode : 214405